

THE MAGAZINE FOR CONSUMER-ELECTRONICS SERVICING PROFESSIONALS

ELECTRONICTM

Servicing & Technology

JANUARY 1989/\$2.50

So you want to service personal computers...

Servicing Sharp's small color TVs • Automate your service testing



**PC servicing special
report**

AN INTERTEC PUBLICATION

With Just One Probe Hookup You Can Confidently Analyze Any Waveform To 100 MHz, 10 Times Faster, 10 Times More Accurately, Absolutely Error Free, Guaranteed Or Your Money Back . . .

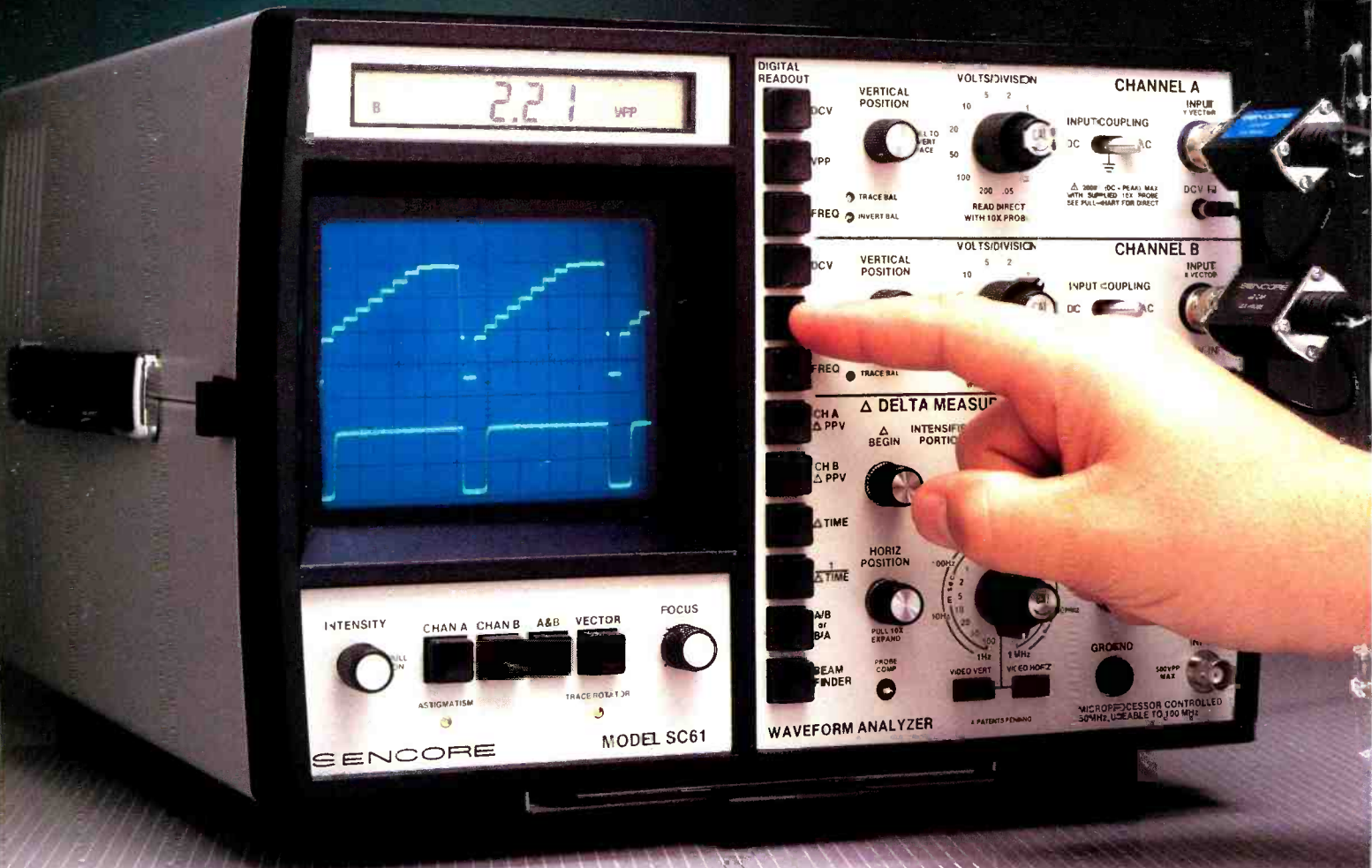

Promises of increased productivity from other oscilloscopes fade fast when compared to the speed and accuracy of the SC61. Eliminate the confusing menus, cursors and complexity of regular oscilloscopes at the push of a button. Here's what the SC61 does for you:

Analyze Waveforms Easily

- Accurate Waveform Display - 60 MHz Bandwidth (usable To 100 MHz) To Test The Latest Digital Circuits.
- Rock-Solid Sync - ECL Logic Circuits And Differential Amplifiers Give Fiddle Free Operation.
- Four Times The Measuring Range - Measure From 5 mV To 2000 Volts (3000 Volts Protection) For Expanded Signal Handling.

Autotracking™ Digital Readings Analyze The Whole Signal

- Autoranging DC Volts Through Single Probe, Even With AC Coupled.
- Automatic Peak-To-Peak Volts - Even If Variable Control Is "Out Of Cal".
- Automatic Frequency Measurements Without Sensitivity Adjustment Or Range Switching.

Digital Delta Tests Analyze Any Part Of The Signal.

- Delta Peak-To-Peak Volts - Peak-To-Peak Volts Of Any Part Of The Signal.
- Delta Time For Any Time Reading - Including Delay Between Traces
- 1/Delta Time - Frequency Of Part Of The Signal - Finds Sources Of Interference Or Ringing.

Frequency Ratio Test - Tests Multiplier And Divider Circuits

Easy To Use - Human Engineered Controls And Virtually No Graticule Counting Or Calculations

The SC61 is designed to give you the measurements you need fast. We make one claim:

"Try the SC61 on your bench for 30 days. If it doesn't cut your present scope time in half, send it back for a complete refund, no questions asked."

Try the SC61 for 30 days, and discover true troubleshooting speed.

Call 1-800-843-3338
In Canada Call 1-800-851-8866

Projection TV Service can be a work-out both physically and financially. The routine is tough. You want to complete the repair on the spot, without the heavy equipment, or the hassle of pick-up and delivery.

The Mitsubishi Projection TV In-Home Service Guide is the answer.

This compact (6" x 9") 3-ring binder is packed with the help you need to repair any Mitsubishi Rear Projection television ever produced...

- PC Board Layouts
- Major Component Locations and Part Numbers
- Voltage Test Points
- Convergence and Adjustment Procedures
- Common Symptoms & Causes

In full color, and INDEXED BY MODEL.

Now the only muscle you'll use is your arm, waving good-bye to your happy customer.

\$29.95

PART NO. T/M VSS101
 C.O.D. Orders accepted
 (800) 533-7278
 FAX (800) 825-6655
 VISA/MC ACCEPTED

Circle (3) on Reply Card

LIGHT AND EASY.

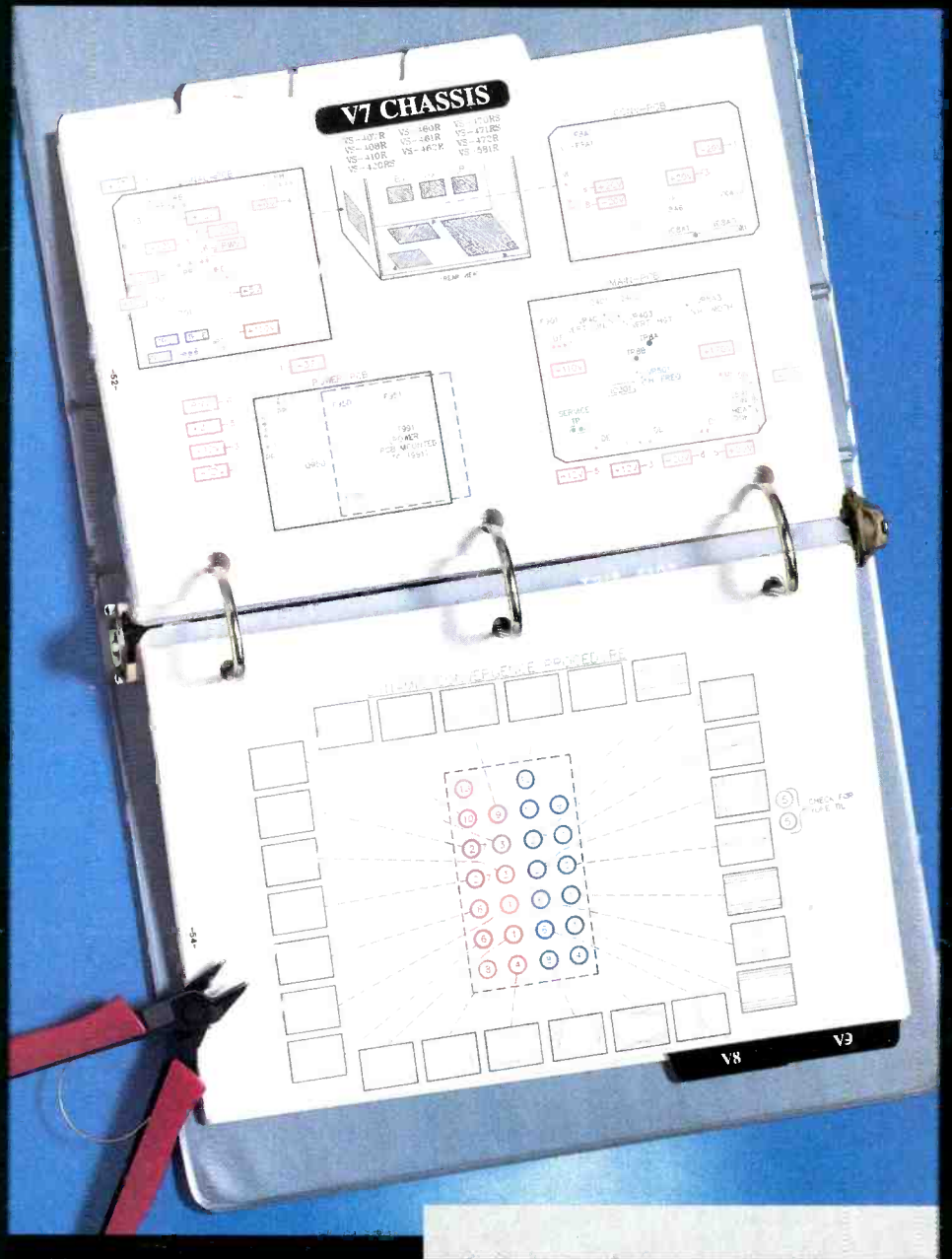

MITSUBISHI
 ELECTRIC SALES AMERICA, INC.

National Parts Department
 P.O. Box 6007•5757 Plaza Drive
 Cypress, CA 90630-0007



Page 10



Page 17

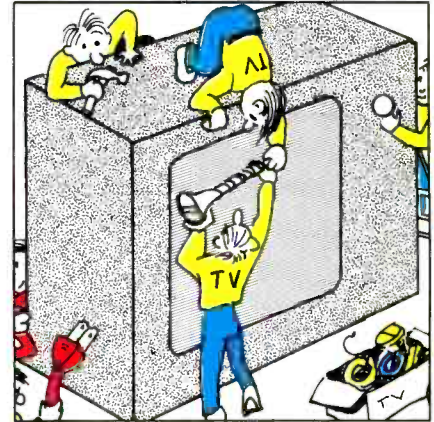

Page 42

FEATURES

10 So you want to service personal computers...

By Dan Evans

With all the new consumer electronics technology out there, electronics servicers don't have to confine their interests to the traditional service areas. One area you might like to get into is computer servicing, but taking the plunge can be a bit daunting. Here's an overview of the factors to consider—getting the right training, finding sources of information and replacement parts, and understanding the equipment itself.

17 Using a personal computer to automate your service testing—Part I

By Greg Carey

Last time you were watching for an intermittent glitch, did it start to feel like you were waiting for certain southerly areas to freeze over? Then, suddenly it's there, it's gone—and you missed it. Wouldn't it be nice if someone else could do all the watching, waiting and catching for you? Someone else can—your friendly personal computer is the perfect sentinel to set on these irritating failures.

42 Servicing Sharp's small color TVs—Part II

By Homer L. Davidson

If you were tuned in to Part I of this series, you now know the basics of how these small-screen TVs work. Now, let's get down to some specifics, such as what tends to fail and what approaches you should take for certain problems.

50 1988 article index

You need an article on automobile electronics, or a book on ICs? No problem: Here's a list of just about everything we covered in 1988.

31 Profax

47 Products

54 What do you know about electronics?

Some ideas that work...and some that don't

57 Audio Corner

Servicing the compact disc player—Part IV

60 Computer Corner

Understanding the effects of software

62 Video Corner

Troubleshooting VCR front loading systems—Part I

64 Technology

Breakthroughs pave the way for semiconductor devices

65 Literature

66 Readers' Exchange

68 Advertisers' Index

DEPARTMENTS

4 Editorial

Make a New Year's resolution—We did.

6 News

7 Business Corner

The business side of things

16 Feedback

25 Symcure

26 Troubleshooting Tips

27 Books/Photofact

28 Test Your Electronics Knowledge

ON THE COVER

As is the case with any new servicing opportunity, PC servicing can require new knowledge, new information and parts sources, and new test equipment. (Photo courtesy of Specialized Products Company, Irving, TX.)

The magazine for consumer-electronics servicing professionals

ELECTRONIC
Servicing & Technology

LEADER

CARVER DENON harman/kardon  HITACHI
NEC ONKYO  PIONEER  SANSUI
SHARP  SONY  TEAC YAMAHA 

These leaders specify Leader.

When servicing electronics, depend on Leader for your test equipment needs.

Leader meets the standards of so many, because we set such high standards in design.

Equip your bench with our standard test equipment as required by manufacturers. Leader continually consults manufacturers and their service facilities to determine what products and features you'll need. The unique features on Leader equipment help you work smarter and increase efficiency.

You'll find hard-to-beat capabilities and value throughout the Leader line.

See all there is to Leader's leadership, and benefit from our more than 34 years of experience. Phone now to discuss your equipment requirements, for a copy of our catalog, and for the name of your nearest "Select" Leader Distributor. All Leader equipment is backed by a TWO-YEAR WARRANTY, and factory service on both coasts.

Call toll-free
1 800 645-5104
In NY State
516 231-6900

Leader Instruments Corporation
380 Oser Avenue, Hauppauge, New York 11788
Regional Offices:
Chicago, Dallas, Los Angeles, Boston, Atlanta
In Canada call Omnitronix Ltd. 416 828-6621

LEADER
FOR PROFESSIONALS WHO KNOW
THE DIFFERENCE

1. LCG-400S NTSC Pattern Generator
2. LVS-5850B NTSC Vectorscope
3. LDC-823S 250-MHz Frequency Counter
4. LMS-238 TV Stereo Generator
5. 3216 AM/FM Stereo Generator
6. LHM-80B High Voltage Meter

7. LSW-333 TV Sweep Generator
8. LAG-126S Audio Generator
9. LMV-185A AC Millivoltmeter
10. LFM-39A Wow & Flutter Meter

11. LDM-171 Distortion Meter
12. LTC-906 Transistor Checker
13. LDM-853A Digital Multimeter
14. LPS-152 DC Power Supply
15. LPM-8000 Laser Power Meter
16. LBO-2060 CRT Readout Oscilloscope

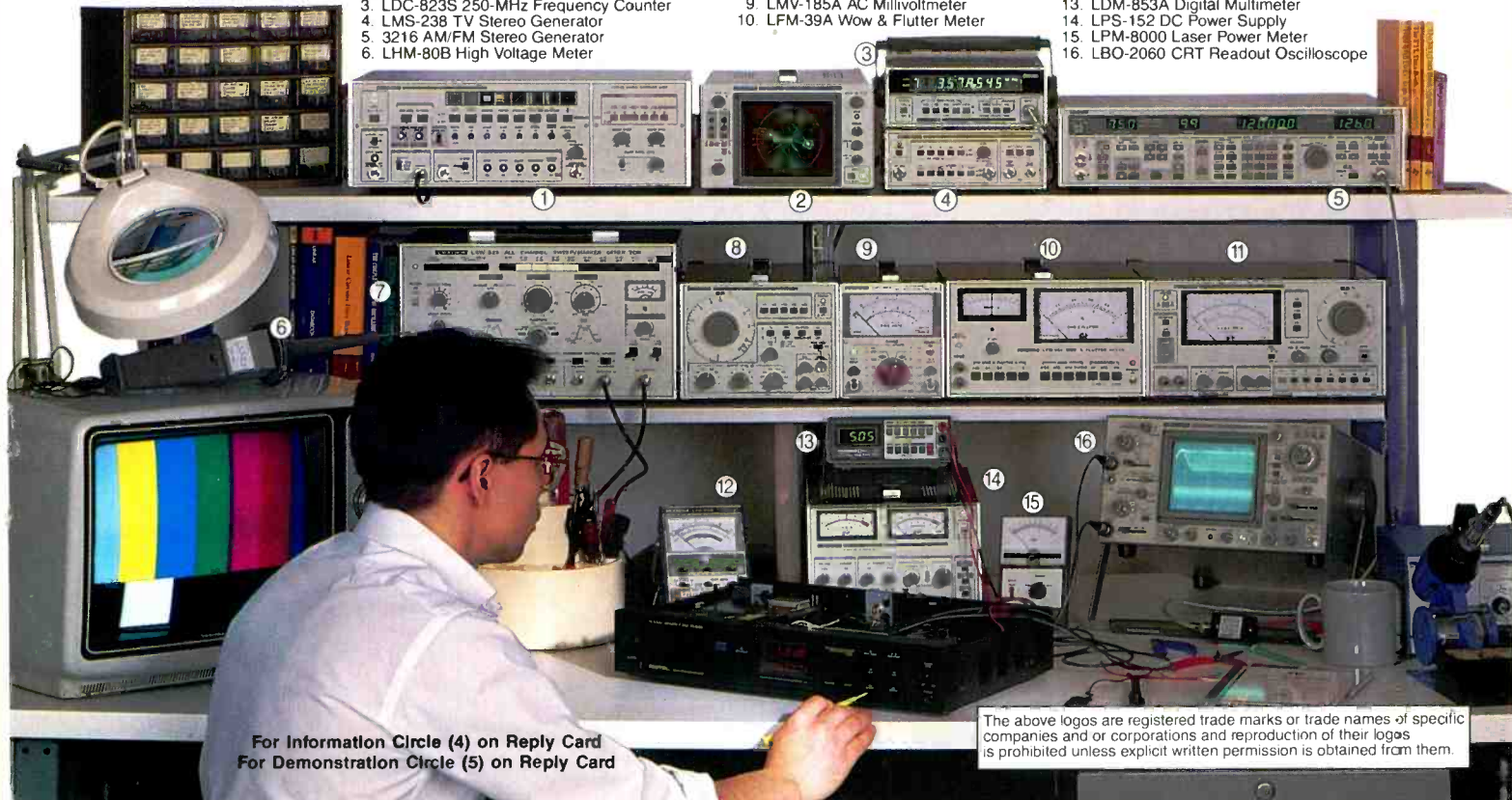

For Information Circle (4) on Reply Card
For Demonstration Circle (5) on Reply Card

The above logos are registered trade marks or trade names of specific companies and or corporations and reproduction of their logos is prohibited unless explicit written permission is obtained from them.

Make a New Year's resolution— We did.

For some time now, consumer-electronics servicing has been experiencing a decline. The introduction of highly reliable semiconductors a number of years ago dramatically reduced the incidence of failures in such products as TVs and stereos and caused serious financial problems to many servicing operations. This change was a welcome eventuality for consumers, but it created difficulties for servicing. Many businesses failed. For a while things looked grim indeed.

The situation has not yet improved to the point where anyone feels Polyannish, but there are bright signs wherever you look. Sales of all kinds of consumer-electronics products are continuing strong, and many of the products the consumers are buying are expensive: high-end VCRs, camcorders, large screen TVs.

But in addition to interest in entertainment products, as prices come down there seems to be increased interest in products that have traditionally been business-oriented—personal computers, facsimile machines, cellular telephones. These products are also highly reliable, which is a good thing for us as consumers, but the sheer numbers of them being bought and put into use mean that there will be considerable opportunities for servicing them.

Of course, when you consider any new product as a potential for servicing business, there is a downside. If you want to service these products, you'll have a lot to learn. In the case of computers, which we talk about in a special report in this issue, you have to learn about software as well as hardware. (See Computer Corner in this issue.) You may have to buy some new test equipment. You will have to establish lines of supply for servicing information and replacement parts.

The important fact, though, is the opportunities are there. The consumer-electronics field is broadening. Where the average home at one time had a

radio or two and maybe a TV, it's not uncommon to find homes with several color TVs, a VCR, a microwave oven, a stereo with turntable, cassette and compact-disc inputs. Many people own their own telephones, and many of these are portable. Personal computers are becoming increasingly common, and it looks like fax and cellular telephones are coming on.

It would probably be to the advantage of most servicing technicians and managers to make a New Year's resolution for 1989 to at least look into all of this new technology and see if any of it fits in with their particular situation. Some of it may make sense for you and some of it may not, but you'll never know what you're missing unless you at least take a look at it.

For our part, we intend to have a look at much of this new technology in 1989, and we'll report on it in these pages. For starters, there's a special report in this issue on personal computer servicing. In fact, we look at both sides of personal computers: servicing PCs and using the PC as a servicing tool. In February we're going to report on the current state of fiber optics. In May we'll be reporting on video cameras and camcorders, followed by an update on extended-definition and high-definition TV.

Finally, in October we'll be bringing you a special report on compact-disk servicing, and we'll be taking an in-depth look at some of the new technologies that are providing new servicing opportunities: computers, facsimile machines, copiers, phones and home automation.

Of course, many of these technologies may not be for you, but any one of them might be a good opportunity if you keep an open mind. We hope our reports during the year will at least give you some food for thought.

Happy New Year.

Nile Conrad Perren



PHILIPS



Introducing a whole new way to look at oscilloscopes.

Operation that's instinctively, unbelievably clear. Information that's detailed, yet free of errors. And intelligence that will speed your work. Philips' micro-computer controlled medium-frequency Smart Series. They could change forever the way you look at oscilloscopes.

HIGH PERFORMANCE WITH A VIEW

- **LCD window.** Large digital indications note all selected functions, instrument settings and parameter values. Instantly. Precisely. With no mistakes. And right where you need them—next to the CRT. Not hidden in crowded frontpanels. Not wasting critical waveform display area. It's a revolutionary idea that facilitates the use of an oscilloscope like nothing else. And it's only from Philips. Once again.
- **16kV CRT.** Higher acceleration voltage and advanced electron optics assure brilliance and spot quality that outshines anything else in this class.
- **Pushbutton simplicity.** Quick, one-function buttons have replaced knobs for faster, surer, more reliable operation.

- **Instant-action AUTOSET.** Philips' intelligent beamfinder automatically selects channel, amplitude, timebase and triggering for error-free display of any input signal. Great for troubleshooting!
- **"Clever" cursors and delayed sweep.** Standard on the PM 3070, "clever" cursors supply immediate amplitude and timing measurements with direct CRT readout. And an exclusive cursor-operated ZOOM function offers the most efficient use of delayed sweep available in analog scopes.
- **Auto-Triggering intelligence.** Provides fast, stable triggering up to 150 MHz.
- **Probefactor compensation in LCD.** It automatically adjusts all readouts for the probe you're using.
- **IEEE compatibility.** For fast computer hook-up and automated production test and calibration.
- **Choice of four models:** Single and dual timebase; 60 or 100 MHz bandwidths.

SUPPORTING VIEW

Philips' medium-frequency instruments come with a 3-year warranty, a 30-day money-back guarantee and all the tech-

nical and service assistance you need. From Fluke—the people who believe that extraordinary technology deserves extraordinary support.

POINT OF VIEW

Call Fluke today at **800-44-FLUKE ext. 77**. And find out how easy it is to change the way you look at oscilloscopes.

Ask for your free copy of our new guidebook, Basic Principles of Oscilloscopes.

John Fluke Mfg. Co., Inc., P.O. Box C9090, M/S 250C, Everett, WA 98206
U.S.: 206-356-5400 CANADA: 416-890-7600
OTHER COUNTRIES: 206-356-5500

© Copyright 1988 John Fluke Mfg. Co., Inc. All rights reserved. Ad No. 0481-F3065170



SMART SERIES OSCILLOSCOPES • 60 & 100 MHz



Circle (6) on Reply Card

NASD plans January school

The National Association of Service Dealers (NASD), a division of the National Association of Retail Dealers of America, will sponsor the 30th annual School of Service Management (SSM) in San Diego, CA, Jan. 28-31, 1989.

Topics will include:

- "Increase Your Negotiating Skills"
- "A Financial Plan for Profits"
- "Computer Servicing as a Profit Center"
- "Planning For the Future"
- "Profitable Product Refurbishing"
- "Service Contracts Hows and Whys"
- "Home Office Product Servicing"
- "Hiring and Firing"
- "Explanation of Laws Important to Service Business Owners"

The 1989 SSM will also sponsor the Best Idea Contest, which features ideas for improving a service business, and the Certified Service Manager (CSM) examination will be presented during the 4-day school.

For more information, contact NASD at 10 E. 22nd St., #310, Lombard, IL 60148; 312-953-8950.

Company offers

"smart-home" technology

Nineteen rural electric cooperatives in 12 states have begun the introduction of new "smart-home" technology, which will provide efficient electrical control and automatic, precise meter reading.

The device, called ACCESS 21, is also designed to provide home security and fire systems, pay-per-view TV and home shopping as they become available through local utilities. The system uses a computerized module that records the use of electricity.

The new technology was developed by Access Corporation, Nashville, and is marketed through an exclusive national agreement between Access and the National Rural Telecommunications Cooperative (NRTC), an organization of 500 rural electric and telephone cooperatives throughout the United States.

Access projects that approximately 50,000 rural U.S. households will have the system within the next two years.

HDTV shows bright future

Market penetration of high-definition television (HDTV) is expected to reach 25% of U.S. households by the end of the century. According to a report by

Robert R. Nathan Associates (RRNA) for the Electronic Industries Association (EIA), HDTV will penetrate the marketplace rapidly, with 10% of U.S. households owning one HDTV set four years after introduction and 25% owning one by the end of the 20th century.

The first part of the report examines the impact of U.S. color TV manufacturing on the economy and assesses the potential impact of HDTV on U.S. color TV manufacturing and sales.

Other highlights of the report include:

- HDTV will be a substitute product for NTSC sets rather than a unique, entirely new product.

- About the same number of workers will be employed in TV manufacturing whether or not HDTV is introduced.

- Annual industry sales volume of color TVs will not be affected by the introduction of HDTV—only the product mix.

- The large screen size of HDTV makes a U.S. production highly likely because virtually all large-screen sets intended for U.S. consumption are produced here.

- 92% of the 13 million HDTV sets sold in 2003 will be manufactured in the United States.

The report is a product of the HDTV Information Center established by the EIA. The center was established to collect and disseminate timely and accurate information on all aspects of the emerging HDTV industry. Specific activities of the center will be to collect and disseminate information pertaining to the status of HDTV in the United States; to provide data on U.S. manufacturing capabilities; to track regulatory and legislative proposals concerning HDTV; to provide technical information; and to commission studies on industry effects and the market outlook.

For a copy of the report, contact the EIA HDTV Information Center at 1722 Eye St. N.W., Suite 200, Washington, DC 20006; 202-457-4992.

EDITOR'S NOTE: In the October issue, ES&T ran an article by Dan C. Anderson called "Locating ESD Hazards." If you would be interested in borrowing the ESD-prevention videotapes mentioned at the end of the article, contact Anderson Effects, P.O. Box 657, Mentone, CA 92359; 714-794-3792.

ES&T

The magazine for consumer-electronics servicing professionals

ELECTRONIC

Servicing & Technology

Electronic Servicing & Technology is the "how-to" magazine for technicians who service consumer electronics equipment. This includes service technicians, field service personnel and avid servicing enthusiasts who repair and maintain audio, video, computer and other consumer electronics equipment.

EDITORIAL

Nils Conrad Persson, *Editor*
 Carl Babcoke, *Consumer Servicing Consultant*
 Tom Cook, *Senior Managing Editor*
 Alisa Carter, *Associate Editor*
 Pamela S. Fleener, *Editorial Assistant*

CONSULTING EDITORS

Homer L. Davidson, *TV Servicing Consultant*
 Christopher H. Fenton, *Circuit Fabrication Consultant*
 Victor Meeldijk, *Components Consultant*
 Kirk G. Vistain, *Audio Consultant*
 Sam Wilson, *Electronics Theory Consultant*

ART

Kevin Callahan, *Creative Director*
 Barbara Miles, *Graphic Designer*

BUSINESS

Cameron Bishop, *Group Vice President*
 Eric Jacobson, *Publisher*
 Greg Garrison, *Sales Manager*
 Stephanie Hanaway, *Promotions Manager*
 Kelly Hawthorne, *Promotions Coordinator*
 Dee Unger, *Advertising Business Manager*
 Catherine Grawe, *Advertising Coordinator*

ADVERTISING

Regional advertising sales offices are listed in classified pages.

ADMINISTRATION

R.J. Hancock, *President*
 Chuck Rash, *Corporate Circulation Director*
 Jane J. Powell, *Circulation Director*
 Jo Ann DeSmet, *Fulfillment Manager*
 Barbara Clare, *Reader Correspondent*



Member, Audit Bureau of Circulation



Member, American Business Press



Member, Electronic Servicing Dealers Association

CORRESPONDENCE

Editorial, advertising and circulation correspondence should be addressed to: P.O. Box 12901, Overland Park, KS 66212-9981 (a suburb of Kansas City, MO); 913-888-4664. Home office fax: 913-888-7243. Home office telex: 42-4156 INTERTEC OLPK

SUBSCRIPTION PRICES: one year, \$19.49; two years, \$32.98 in the USA and its possessions. Foreign countries: one year, \$23.49; two years, \$36.98. Single copy price: \$2.50, back copies, \$3.00. Adjustment necessitated by subscription termination to single copy rate. Allow 6 to 8 weeks for new subscriptions.

PHOTOCOPY RIGHTS: Permission to photocopy for internal or personal use is granted by Intertec Publishing Corp. for libraries and others registered with Copyright Clearance Center (CCC), provided the base fee of \$2 per copy of article is paid directly to CCC, 21 Congress St., Salem, MA 01970. Special requests should be addressed to Eric Jacobson, publisher. ISSN 0278-9922 \$2.00 + 0.00

Electronic Servicing & Technology (ISSN 0278-9922) is published monthly for \$19.49 per year by Intertec Publishing Corp., 9221 Quivira Road, Overland Park, KS 66215. Second-class postage paid at Shawnee Mission, KS and additional mailing offices. POSTMASTER: Send address changes to ELECTRONIC SERVICING & TECHNOLOGY, P.O. Box 12960, Overland Park, KS 66212.



©1989 All rights reserved.

The business side of things

By William J. Lynott

Life as your own boss is terrific. No time card to punch. Freedom to make your own decisions. The chance for a big income and financial independence.

Right?

Well, not always. As any electronics servicer knows, there are lots of headaches, not the least of which is the ever-present risk of failure. Figures published by the Small Business Administration (SBA) indicate that about half of all newly formed small businesses are liquidated or sold within two years, and four out of five will have bitten the dust within ten years. As if that weren't scary enough, it turns out that service-type businesses do even more poorly than the general averages.

Just another statistic?

With statistics such as these to face up to, every service dealer (or technician thinking of going into business for himself) ought to be well-informed about the underlying causes of business failure and what steps can be taken to avoid them.

You may be inclined to think that in a technically oriented business such as electronics servicing, the biggest reason for failure would be lack of technical expertise. Definitely not so. SBA studies and independent studies have clearly established that the greatest single cause of small business failure, by far, is poor management.

Dun & Bradstreet agrees. This venerable old firm analyzed more than a million business failures over a hundred-year period. Their conclusion was pointed: Lack of managerial experience and aptitude accounted for some 90% of all failures.

Small service companies provide a good example. I seriously doubt that many fail because of a lack of technical expertise on the part of the owners. I

know for a fact, though, that many disappear every year simply because the founders had neither sufficient interest in, nor aptitude for, the business side of running a business.

That's not so hard to understand, I suppose, when you stop to consider that the very qualities that inspire some people to declare their independence through entrepreneurship might also lead them to look unkindly at the prospect of being tied down by the sort of mundane chores required to run a small business.

Be that as it may, those service dealers who are willing to face up to the facts and do something about them will still be in business long after others have failed.

Increasing your odds

When I write on this subject, I always think of a technician friend of mine who failed in his first attempt at business. He decided to switch the odds to his favor and enrolled in business administration classes in night school. His new service business is thriving now and he is actively planning for diversification and growth.

Of course, not everyone can go to college while running a business, nor is it necessary. What is necessary is a willingness to recognize that reasonable management skills are a prime requisite for business success. The good news is that those skills can be developed by almost anyone willing to devote the necessary time and attention to the task.

For example, studies attempting to pin-point the exact management deficiencies that cause so many small-business failures usually reveal a failure to keep adequate records as one of the chief villains. That's doubly unfortunate because recordkeeping is not only a simple job, it's absolutely essential for optimum business success.

Furthermore, records that are properly designed and maintained actually

assist the service dealer. In the long run, they make his job easier and his business more profitable. Good records allow the dealer to see where he's been, but even more important, they allow him a peek at where he may be headed in the future.

As you know, Uncle Sam requires every business to maintain certain records. Such things as wage/hour and profit/loss statistics are required in order to establish tax liability. But please remember that requirements of this sort were not conceived as a help to the business owner; they are intended solely to provide evidence that the laws of the land are not being violated. Unfortunately, these mandatory records are the only ones kept by many small service dealers.

Basic recordkeeping

One of the records that I find is often shunned with a vengeance is the basic business budget. Keeping and using a budget is a simple job that provides the service dealer with an operating tool of immense value. In its most basic form, a workable budget can be committed to a single piece of paper in less than an hour. I don't believe I have ever known a service dealer to abandon the preparation and use of a budget once he became convinced to give it a try.

That's the sort of thing this monthly column will be all about. In coming issues of **ES&T**, we're going to be discussing management techniques that can be put to work to help make your business grow and prosper—lots of facts, very little theory.

It's no accident, you know, that some dealers continue to grab an increasing share of the electronics-servicing market each year while others are caught up in a continual struggle to pay the bills. Helping you become one of the former and not one of the latter will be our purpose in bringing you Business Corner.

ES&T

Lynott is president of W.J. Lynott, Associates, a management consulting firm, and publisher of the Service Dealer's Newsletter.

An affordable portable is

Price/Bandwidth

\$4995 100 MHz 2230 DSO*, 20 MS/s, 4K Record Length, 100 ns Glitch Capture, Cursors, CRT Readout, GPIB or RS-232-C Option

\$3995 60 MHz 2221 DSO, 20 MS/s, 4K Record Length, 100 ns Glitch Capture, Cursors, CRT Readout, GPIB or RS-232-C Option

\$2995 60 MHz 2220 DSO, 20 MS/s, 4K Record Length, 100 ns Glitch Capture, GPIB or RS-232-C Option

\$2995 100 MHz 2236 Two Channel, Counter/Timer/DMM, Dual Time Base

NEW **\$2795** 100 MHz 2247A Four Channel, Counter/Timer, Store/Recall of 20 Front Panel Setups, Auto Setup, Smart Cursors™

\$2395 100 MHz 2246A Four Channel, Store/Recall of 20 Front Panel Setups, Auto Setup, Smart Cursors™, Dual Time Base

\$2395 50 MHz 2210 DSO, 20 MS/s Sample Rate, 4K Record Length

NEW **\$1495** 20 MHz 2201 DSO, 10 MS/s Sample Rate, 2K Record Length, Hard Copy (RS-232-C) Option

\$1795 100 MHz 2245A Four Channel, Auto Setup, Cursors, Dual Time Base

\$1595 100 MHz 2235 Two Channel, Dual Time Base

\$1095 50 MHz 2225 Two Channel, Horizontal Magnification (x5, x10, x50)

\$695 20 MHz 2205 Two Channel

*Digital Storage Oscilloscope

Check the prices and performance. You'll find the best measure of both in Tek 2200 Series Oscilloscopes. Twelve scopes with bandwidths ranging from 20 to 100 MHz. Two and four channels. Analog and digital. And prices starting at just \$695.

Select for such features as automatic setup, time and voltage cursors, built-in DMM functions, Counter/Timer and dual analog/digital capabilities at the push of a button.

These are scopes you'll appreciate for their well-proven reliability, achieved through simplified, practical internal design. They come

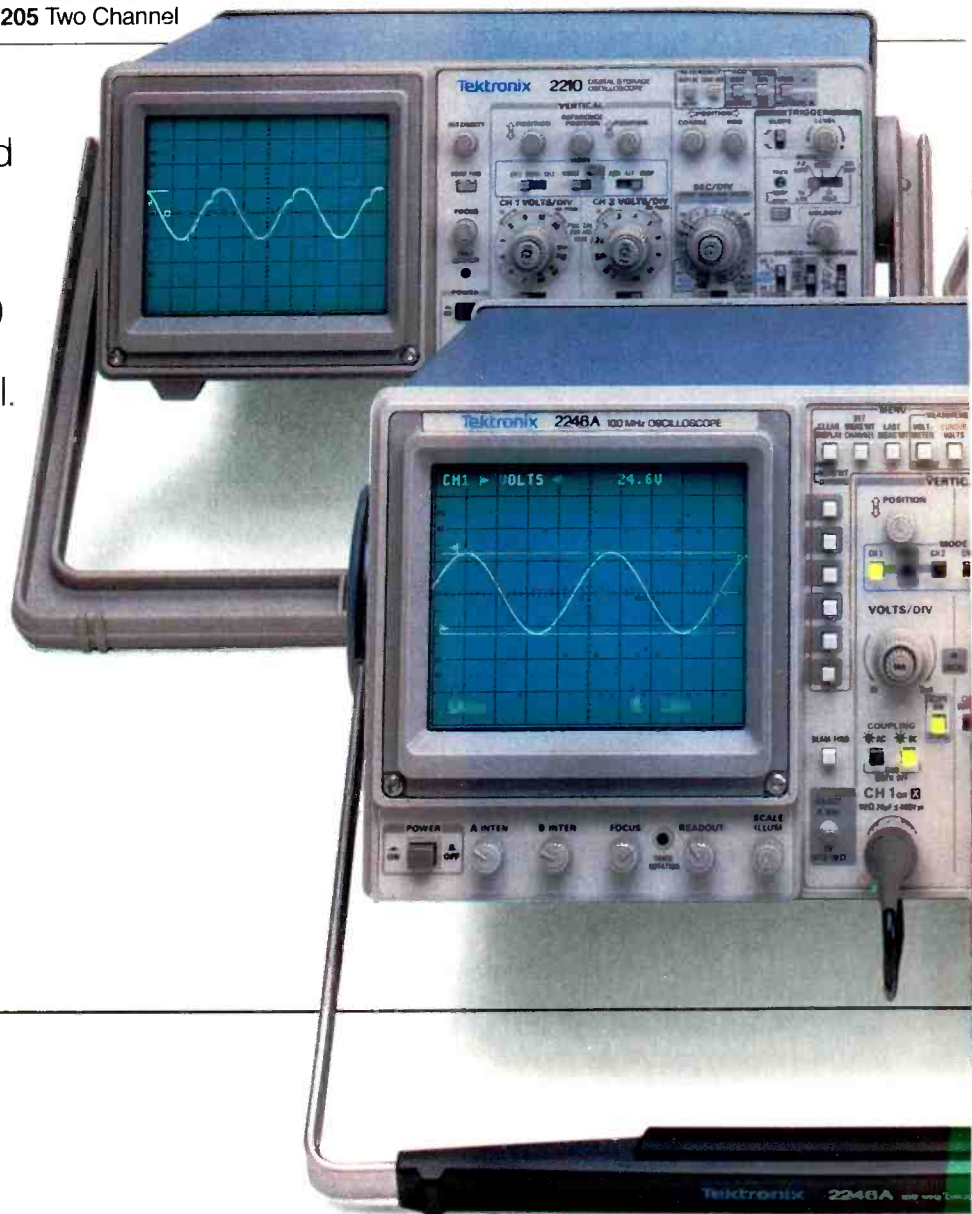

s right within your range.

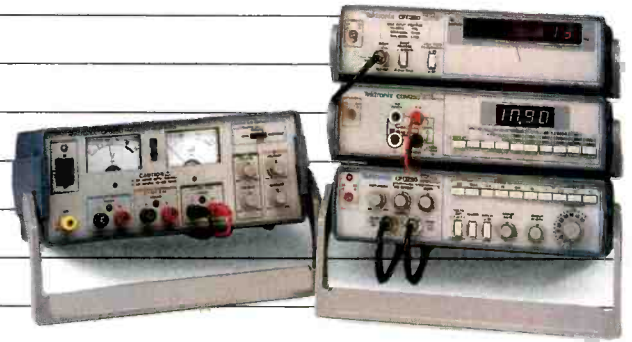

Industrial-quality test instrumentation starting at \$295.

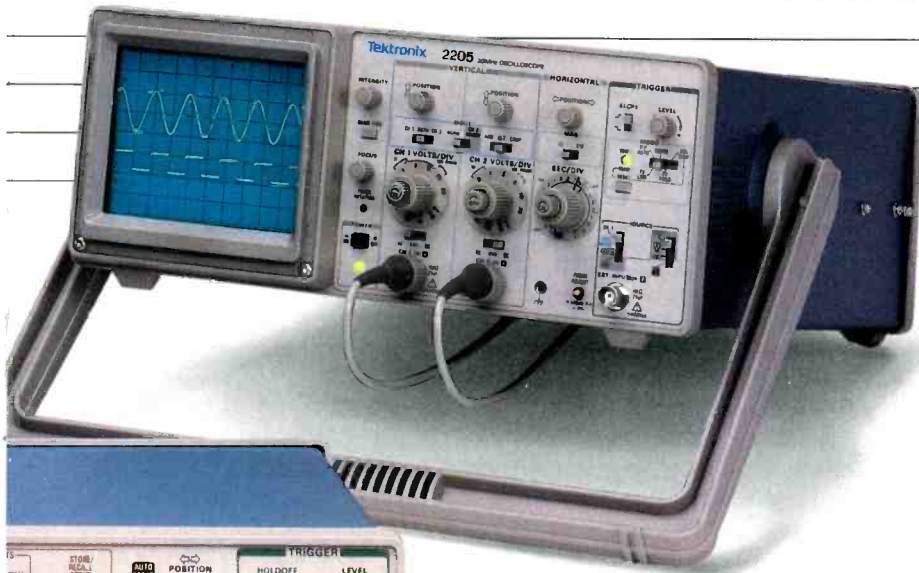

complete with probes and comprehensive Tek warranty that includes the CRT.

Ask those who own, use and rely on one—on the bench or in the field. There's just no substitute for genuine Tek quality. At any price. And at these prices, all the better.

Order one to go. Ask your Tek representative to set up a demo. Or call Tek direct. No need to settle for less when there's a top quality Tek portable with performance and price right within your range.

LISTED



For easy ordering or more information, call Tek direct:

1-800-426-2200



Tektronix®
COMMITTED TO EXCELLENCE

Circle (7) on Reply Card

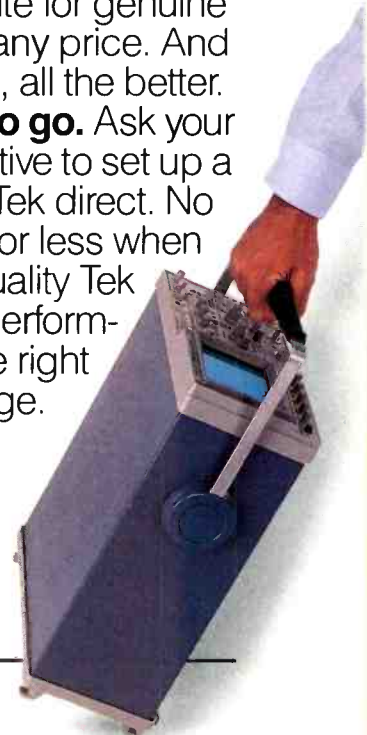



So you want to service personal computers...

By Dan Evans

If you're thinking about getting into personal computer maintenance, or if you've recently taken the plunge into handling personal computer repairs, this article is for you.

The items to be examined here will include training, finding sources of parts and information, approaches to fault-isolation, details on some very helpful diagnostic tools, and the fixes for a sampling of specific problems. The focus of this material will be technical, but before we get to the nuts and bolts, let's step back and take a look at some of the forces at work in the personal computer industry.

This is an immature industry, now just ten years old. And it has only been in the last five years that large numbers of third-party service companies have emerged.

So what is third-party service? Think of it this way—the manufacturer of a product is the first party and the distributor or reseller is the second party. If a company is servicing the product but is not connected to a particular manufacturer or reseller, that company is a third-party service company. In turn, fourth-party maintainers are those companies that rework (repair) the boards or modules that aren't returned to the manufacturer for repair/replacement or that aren't fixed at some other level.

Evans is vice president of marketing for National Advancement Corporation.

To the extent that they don't do their own rework of boards and modules, third-party service tends to use field-service techs who do most of their repairs at the customer site. Fourth-party maintainers primarily use bench techs who rarely need to see or talk to a customer. Although some people can do both kinds of technical work well, it is usually helpful to classify service people as bench techs (task-oriented problem solvers) or field techs (people-oriented problem solvers).

A significant proportion of the people now at work in the service side of the industry have been in it less than three years. There may be a lot of computer-servicing technicians out there, but many of them have not yet had the time or the training to achieve a high level of expertise.

The same thing is true of service providers in general. There seems to be a tremendous amount of competition for computer service business, especially in larger cities, but surveys of computer owners reveal the belief that it is difficult to find quality service at a reasonable cost. This is a major factor in the current trend toward self-maintenance, especially at corporations and institutions where there are larger numbers of personal computers.

Another trend in the works is for organizations using outside maintenance to have the work done on a pay-as-you-go basis (time and materials billing) rather than paying a monthly or annual

fee in advance for a traditional service contract.

IBM itself accounts for more than half of all the personal computers that have been sold to the Fortune 1500. The vast majority of corporate and institutional computers are IBM or IBM-compatible. *Compatible* means different things to different people, and it is important to distinguish degrees of compatibility.

To be called IBM-compatible, a machine should be able to run most of the programs that an IBM PC can run. A machine that is software-compatible may have little hardware compatibility. The best example of a compatible is a machine that runs virtually all of the software that an IBM can run and can also use the same modules, cards and peripherals (devices that add functions to a computer system) as the corresponding IBM system.

Apple computers, mainly the Apple II and Macintosh series, account for a relatively small portion of the computers installed in businesses and institutions. Other systems that are neither Apple II-nor IBM-compatible make up no more than a few percentage points of the business/institutional marketplace.

Although IBM has the biggest installed base numbers, there are good opportunities to repair the machines that are not as well known because there is less competition for that service business. The printer marketplace is not dominated by one manufacturer, and service on printers in general (especially

on the less common printers) is harder to find in some areas.

Now, with some of the commonly used terms and background information out of the way, let's look at some specific issues.

Training

In a business where there is a constant flow of new machines, new peripherals, new diagnostics and test equipment, plus new failure trends in particular types of components, there is a compelling need for training from a variety of sources.

On top of this, personal computer manufacturers are often very stingy with technical information, sometimes as a matter of oversight, sometimes because they want to reserve rework for themselves, and sometimes because of their concerns about clones or knock-offs. A computer service business must institute regular training if it is to grow and succeed long term.

Many of the computer manufacturers offer entry-level maintenance training on their products, but these training programs may be difficult to get into unless you are an authorized reseller of the product. In some cases, you may also find the content less than satisfying.

One symptom of any new industry is that there is more than the usual share of opportunists. There are a number of third-party training companies that claim to teach computer repair. Most of these classes are oriented to the entry-

level tech, and some of them would be regarded as inadequate even for the person with little experience in any kind of electronics repair.

In evaluating the potential of any class, a high priority is to check the references. Talk to others who have attended the class or sent people to the class. Ask specific questions based on your needs.

Is the training hands-on? Research on how we learn shows that seeing a demonstration of a skill or technique is far more effective than reading or hearing about it. When a student then gets to practice the technique with the supervision of an instructor, the highest level of learning and retention occurs.

Find out how much component-level information there will be in a prospective class. Ask about class size and the ratio of participants to systems for hands-on instruction and practice. What kind of documentation comes with the training? Does the training include any help in finding sources of replacement parts? Is there any provision for



technical support or continuing education after the class is over? Does the training come with any guarantees or assurances of satisfaction? Is there a penalty for cancelling or rescheduling a class? Getting the answers to these questions will help eliminate risks and assure the value of your selection.

Parts and information sourcing

Each service operation needs to develop its own database of sources, but

there are some good places to start. One publication that many computer repair operations are not aware of is Data Sources, a biannual directory of virtually all computer companies and their products (whether hardware, software or services) from Ziff-Davis Publishing. Subscription information is available from Data Sources in Cherry Hill, NJ (609-354-4999).

The D.A.T.A. Books series from D.A.T.A. in San Diego, CA (619-

578-7600), is a good guide to replacements and alternate sources for various types of components.

The Electronics Engineers Master Catalog series from Hearst Business Communications in Garden City, NY (516-227-1300), may already be familiar to people now repairing other kinds of electronic devices.

Although they can be frustrating to deal with, the hardware manufacturers are an essential source of information. Many service vendors don't try to contact manufacturers because they assume that they won't be helped. Others make a few attempts and then quit because they don't get the information they need.

One secret of success in this area is to start by just getting the name of a person who can help you. This person may not always be in the technical support area. It may be someone in engineering, or it may be a knowledgeable salesperson.

Develop a telephone relationship with these people and treat them well, even when they can't help you. Perhaps there will be times when you can give them information. Find out if they have direct or private phone numbers, and ask when it's easiest to reach them.

As mentioned before, some training companies may help with parts and information sourcing. National Advancement Corporation, for example, provides its graduates with a toll-free technical help line, a database of parts suppliers, and regular mailings of technical updates on computer service.

11XX	Asynchronous (COM 1) communications adapter	These tests are only accurate for the IBM async adapter. Wrap plugs must be installed when testing. U5 must be set for RS-232 (pin 1 at top) or adapter will fail.
12XX	Alternate async (COM 2) communications adapter	Versions 2.12 and 2.20 of diagnostics due to a bug in the software will occasionally show a failure on an operational adapter.
13XX	Game control adapter	If using 2.06 IBM diagnostics and no game controller is installed, ignore this error. It is a bug in the software.
1301	Adapter test failed	
1302	Joystick test failed	

Figure 1. For many errors that occur in an IBM personal computer, the screen may flash a message that gives the operator or the servicing technician an idea of what went wrong—if they know the numeric code. This is a sample of some of the numeric codes and what they mean.

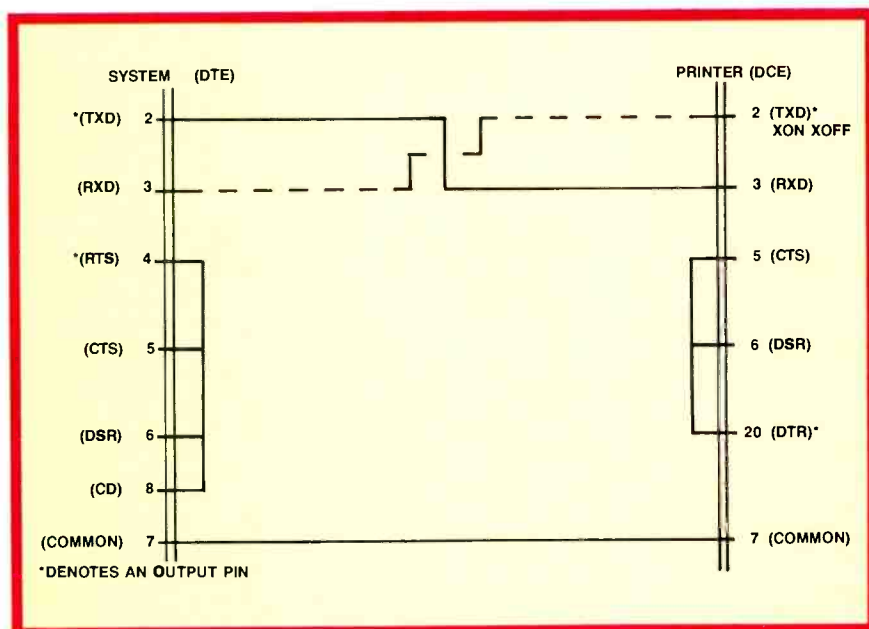

Figure 2. For a computer to send data to the printer in an RS-232 system, pins 2 and 3 must be flip-flopped as shown by the interconnecting cable.

Approaches to fault-isolation

A computer-servicing technician, like any other kind of technician, needs to understand the equipment well enough to know the logically correct sequence of tests needed to isolate the fault.

In actual practice, however, many repairs do not require a great deal of fault isolation. All technicians or mechanics tend to learn the common failures of the equipment they work on a great deal. The best ones keep records of particular failures and how they were handled.

Here are some examples of solutions to personal computer problems that are part of National Advancement's 30-hour, hands-on class. Much of this material is taken almost verbatim from the NAC Reference Manual.

Device: IBM monochrome monitor (5151)

Problem/Solution 1: A blank screen indicates a bad fuse, probably caused by a shorted transistor (location TR23; this can be a BU406, BU407 or BU408). Do not use a cross-referenced component.

To disassemble the monitor, disconnect the power and signal cables from the system. To remove the two screw covers on top of the monitor, use a small, flat-blade screwdriver and pry up the back of each cover. Next, remove the two Phillips screws from the top of the monitor and turn it face down. Remove the six screws on the bottom of the case. Don't remove the feet or the two screws next to where the cables enter the monitor. Pull both cables from behind the plastic flange. You can now lift off the case.

If you still do not have a picture after replacing the fuse and the transistor, check for a glow in the back of the CRT. (This will tell you if you have power.) If there is no glow and the fuse is still good, the main power transformer probably has an open primary and needs to be replaced. Take care to avoid getting shocked while the power is on.

If you have no picture but you do have a glow in the back of the CRT after replacing the fuse and the transistor, quickly turn off the monitor. Check the heat sink at the transistor you just replaced (location TR23), being careful not to burn yourself. If it is getting hot, the flyback transformer is shorted and needs to be replaced. This part is available from Computer Parts Exchange (CPX), Chatsworth, CA; 818-709-4003. CPX also has a facility in New Jersey (201-389-8333). Another source for this part is Acetron Data-products, Van Nuys, CA; 818-786-9789.

Problem/Solution 2: The symptom here is full brightness unaffected by the brightness control. This indicates a bad resistor (location R₅₁₅; its value is 180kΩ at 1/2W).

Problem/Solution 3: The symptom of a third frequent failure on the 5151 is a horizontal line across the screen. This indicates a bad chip (location IC401; it is a TDA1170 IC).

Device: Seagate ST-225, ST-238 or ST-213

Problem: Drive loses data and format (more noticeable with temperature changes).

Solution: The problem is caused by ex-

The Philips ECG DT-200 Temperature Adapter turns your digital multimeter into a thermometer!

Our DT-200 Temperature Adapter can turn your digital multimeter into a direct-reading thermometer for minimal additional cost. Take a look:

- uses K-type thermocouple (included)
- temperature to voltage converter with a linear 1.0mV DC/degree output with $\geq 10M\Omega$ input impedance meters
- 6 output jacks assure perfect fit with almost any digital multimeter
- measurement range of -50° to $-2372^\circ F$ and -50° to $1300^\circ C$

Contact one of our more than 900 distributors, or call 1-800-225-8326 for the name of the distributor nearest you. It just might be the smartest call you make all week.



The Smart Choice.
Philips ECG

A North American Philips Company
Circle (8) on Reply Card

The ECG pocket-sized DM-51 Multimeter is packed full of features!

The ECG[®] DM-51 Multimeter is part of our new line of compact multimeters that combine small size with big features. The DM-51 can easily be carried in a repair kit, bag, or even your shirt pocket!

- measures up to 200 MΩ
- up to 10 amps DC
- test batteries -9V, 1.5V
- transistor hFE test
- diode test
- continuity beeper

Contact one of our more than 900 distributors, or call 1-800-225-8326 for the name of the distributor nearest you. It just might be the smartest call you make all week.



The Smart Choice.
Philips ECG

A North American Philips Company

ECG Replacement parts keep VCR's in top shape!

To replace VCR mechanical parts look no further than Philips ECG.[®] Our new line can replace mechanical parts for most major brands of VCR's and our catalog contains the most accurate cross-references by part number and model number. Other features:

- line includes 13 pinch rollers, 33 idler wheels and assemblies, 4 idler replacement tires and 46 belt kits
- individual belts available

Nobody makes it easier to get VCR replacement mechanical parts than Philips ECG! Contact one of our more than 900 distributors, or call 1-800-225-8326 for the name of the distributor nearest you. It just might be the smartest call you make all week.



The Smart Choice.
Philips ECG

A North American Philips Company

Circle (26) on Reply Card

pansion of the chassis as the drive warms up. The board mounted on the chassis does not allow the case to expand normally, and the drive goes out of alignment. To solve this problem, just loosen the screw that fastens the board to the chassis at the front of the drive and leave it a little loose. Then reformat the drive (both controller level and DOS format). Be sure you have an up-to-date backup of the drive before starting this procedure.

Device: Floppy disk drive

Problem/Solution: A floppy disk drive is the device on the personal computer that is most likely to fail. In the field, floppy problems are most easily handled

by replacing the drive with a unit that is known to be good. And here's a catch—many service organizations do not do their own floppy-drive alignments or repairs. They replace with new drives or drives that have been fixed by a supplier. As a result, they don't know for sure if their replacement is properly adjusted and aligned.

The usual justification for depending on outside sources is that new floppy disk drives are inexpensive or that alignment procedures are too time-consuming to do in-house. Often we have had technicians tell us that they throw "bad" disk drives in the trash. When we hear that, we ask them if they have any they want to throw our way. Over the last few years, we've been

given lots of "bad" floppy disk drives, and we've purchased many as scrap for \$5 or less per unit. We've had hundreds of "bad" drives brought to our classes.

Typically we find that about 35% are in perfect working order, and do not need any adjustment or alignment. About 50% need only three to five minutes of attention to get the alignment right. About 15% need a read/write head, motor or chip (usually a pre-amp or stepper driver chip).

But the issue here is not just cost-effectiveness, it's quality control. Unless there is someone in the organization who can check drive alignments and adjustments, there will be solutions where one problem drive is traded for another or where good drives are routinely replaced because a particular tech can't think of anything else to do with sticky problems.

It is also important to remember that when someone declares something unrepairable, it may simply mean they don't know how to fix it. Repair is not always the cost-effective solution, but we've fixed a lot of "unrepairable" devices for a fraction of the replacement cost. Recently, a student brought in an IBM monochrome monitor deemed "unrepairable" by a fourth-party maintainer. It was fixed in a few minutes with pennies in parts.

Device: IBM PC or PC/XT

Problem/Solution: System appears not to be getting power although the fan is running. There is no display, no beep and no error message when power is turned on. Replacing the power supply doesn't help a bit. Replacing the system boards fixes the problem, but what's wrong with the system board?

To understand this one, we need an explanation of how the power-on self test (POST) works. The IBM POST routine, located in the BIOS ROM, runs numerous tests of the system board and add-on boards. If any of the first 11 of these tests fails, no cursor and no error message will appear. The system appears dead, even if the failure is simply a bad chip in the first 16K (critical bank) of RAM.

Because the IBM POST checks critical bank RAM during the first 11 of its tests, it will not continue if a failure is detected there. This problem with a bad RAM chip in the first 16K accounts for about 50% of all "dead" system boards. Failure of any of the other first

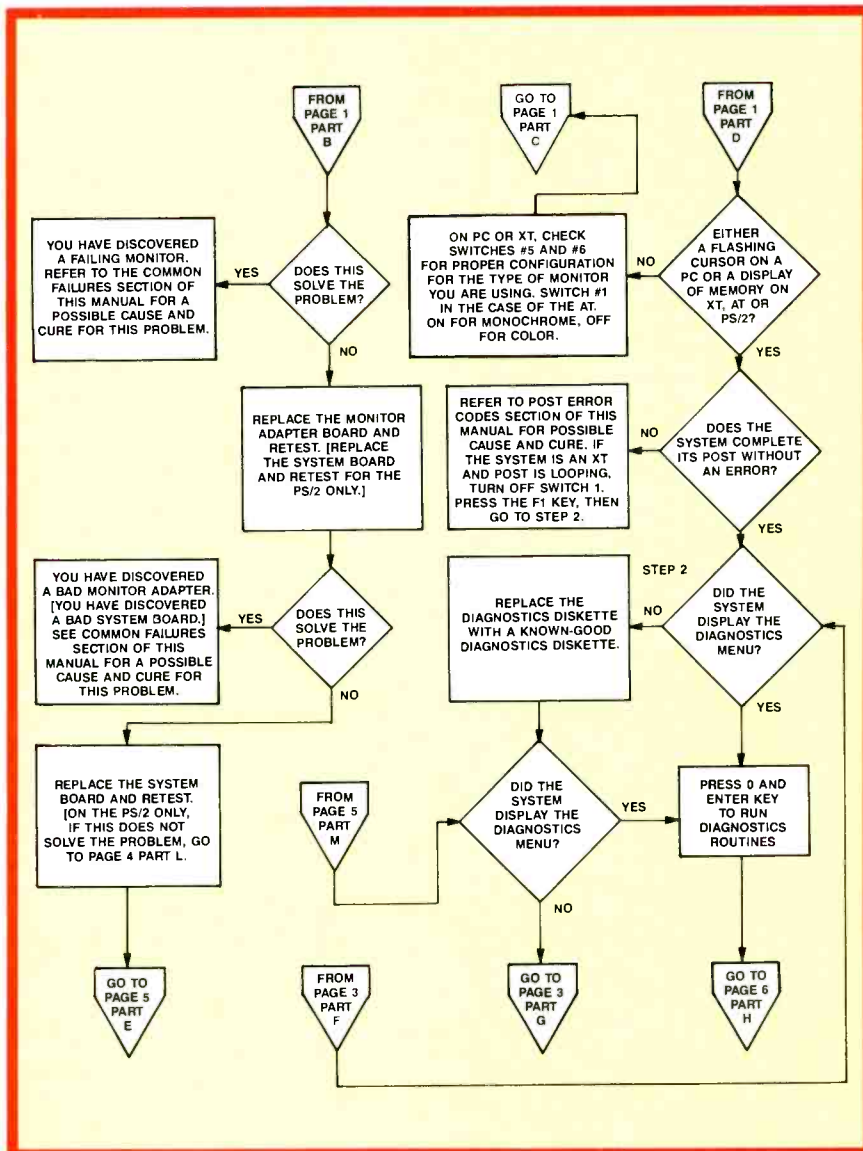
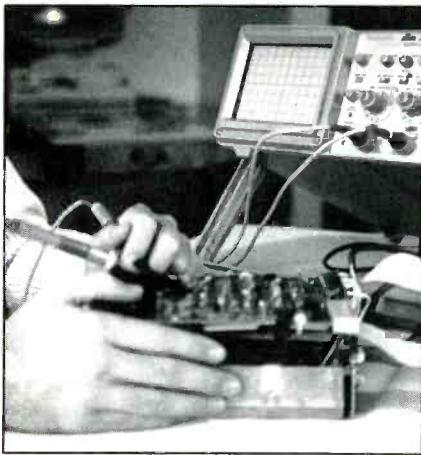

Figure 3. This is an example of the kind of fault-isolation flowcharts that are available to help in diagnosing problems in personal computers.



Proper alignment can save a floppy disk drive that would otherwise be scrapped.

11 tests will also result in an apparently dead system board.

In the case of the IBM PC, some compatibles and sometimes the IBM PC/XT, the critical bank of RAM is soldered in, making it impractical to troubleshoot by systematically replacing chips. The most typical solution for this kind of failure has been to replace the system board and send the "dead" board to IBM or a third- or fourth-party maintenance company for repair or exchange at a cost of \$70 to \$225 or more. Labor and shipping costs, the supplier's turnaround time, and spares inventory add to the cost of having boards repaired outside.

There are two very useful tools for dealing with system-board problems. One is the WindsorPOST diagnostic ROM module, made by Windsor Technologies of San Rafael, CA (415-456-2200). It can be used on the IBM PC, the IBM PC/XT and most compatibles that closely adhere to the IBM video standards. Windsor has just released a version for the AT.

To use the WindsorPOST, the socketed BIOS ROM is removed (this is the ROM that contains the IBM POST), and the WindsorPOST module is installed in its place. The WindsorPOST ROM performs 36 diagnostic tests on power up and will pinpoint the problem in an otherwise "dead" board about 70% of the time.

The second tool is the RACER diagnostic card from Ultra-X of Santa Clara, CA (408-988-4721). The RACER card will find a few problems that the WindsorPOST ROM will not, and it comes with ROM sets that allow it to be used on the IBM PC, IBM PC/XT, IBM PC/AT (286), compatible or 386

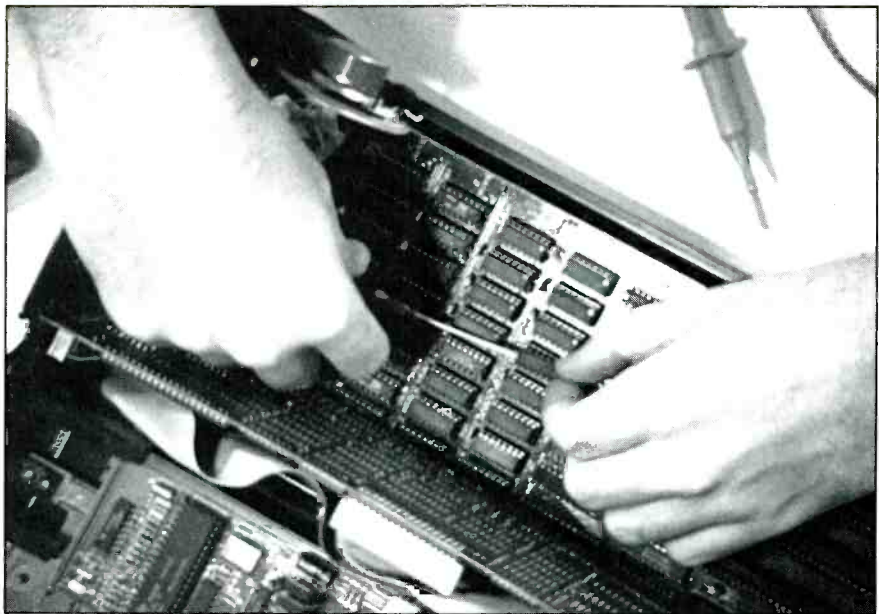

Use care when replacing integrated circuits. Carefully pry out the faulty chip and make sure all pins are properly aligned before installing a replacement.

machines. The acronym RACER stands for *real-time AT/XT computer equipment repair*.

Informal statistics from graduates of the NAC training programs indicate that at least 70% of all system-board failures can be isolated to the component (chip) level with the WindsorPOST module and/or the RACER diagnostic card, without the use of an oscilloscope or logic probe. Suggested retail for the IBM PC/XT version of the WindsorPOST ROM module is \$295, and suggested retail for the AT version is \$395. The RACER card has a suggested retail of \$579.

Another 15% of system-board failures can be attributed to the clock circuit, non-maskable interrupt (NMI) circuit, or a data/address line failure. These problems can often be isolated with an oscilloscope and the following procedures:

1. Jumper pin 10 to pin 20 on the DMA (direct memory access) controller (location U35 on the IBM PC, U28 on the IBM PC/XT) and turn on the system to test. If this solves the problem, replace the DMA Controller.
2. Check for a 4.77MHz clock on pin 8 of the clock chip (location U11 on the IBM PC, U1 on the IBM PC/XT). If no clock is detected, possible causes are the clock chip or the crystal.
3. Check for 4.77MHz clock at pin 8 of the 74LS04 (location U51 on the IBM

PC, U89 on the IBM PC/XT). Replace the chip if there is no clock.

4. Check for 4.77MHz clock on pin 4 of the time delay (location TD2 on the IBM PC or the IBM PC/XT). If no clock is present, remove the time delay and replace with a 470Ω resistor across pins 1 and 4 on the system board.

5. Check the signal at pin 9 of the 74LS74 (location U96 on the IBM PC, U86 on the IBM PC/XT) for a high or floating signal. If a high or float is found on this pin, replace the chip. This signal is the ALLOW non-maskable interrupt (NMI).

6. Try replacing the 8088 processor, which is socketed.

These steps have been found to be effective for troubleshooting about 85% of all system-board failures within five minutes. Most of the other 15% are usually attributed to an address or data line being pulled high or low. In many cases, these problems can also be spotted with an oscilloscope. It is recommended that inexperienced technicians not attempt to remove or replace chips that are not socketed.

If you have questions, please feel free to contact National Advancement Corp., 2730-J South Harbor Blvd., Santa Ana, CA 92704; 714-754-7110. Personal computer repair material was developed by Don Doerr, NAC's director of technical services.



Symcure guidelines

ES&T is now paying \$60 per page for accepted Symcure submissions.

The term *Symcure* is a contraction of two words: symptom/cure. Problems that are published in the Symcure department are those that have occurred more than once. This is the kind of problem you can solve without even a second thought because you've already seen so many of that particular brand and model of set with those symptoms. In almost every case, it will be the same component that fails or the same solder joint that opens. Submissions must follow these rules:

- Each submission must consist of *seven* individual symptom/cure units on a single brand of TV set.
- If there is no Sams Photofact on the unit, we cannot accept the submission.

Troubleshooting Tips guidelines

ES&T is also paying \$25 per item for accepted Troubleshooting Tips.

A Troubleshooting Tip describes a procedure used to diagnose, isolate and correct an actual instance of a specific problem in a specific piece of equipment. Its value, however, lies in the general methods described.

A good Troubleshooting Tip has the following elements:

- It should be a relatively uncommon problem.
- The diagnosis and repair should present something of a challenge to a competent technician.
- It should include a detailed, step-by-step description of why you suspected the cause of the problem and how you confirmed your suspicions—anything that caused you to follow a false trail also should be included.
- It should describe how the repair was performed and any precautions about the possibility of damage to the set or injury to the servicer.

For Symcures and Troubleshooting Tips, please also include:

- the manufacturers name;
- the model and chassis number;
- the Sams Photofact number;
- a sketch of the schematic area where the fault was found. (Include a major component such as a transformer or transistor to provide a landmark.)

Feedback

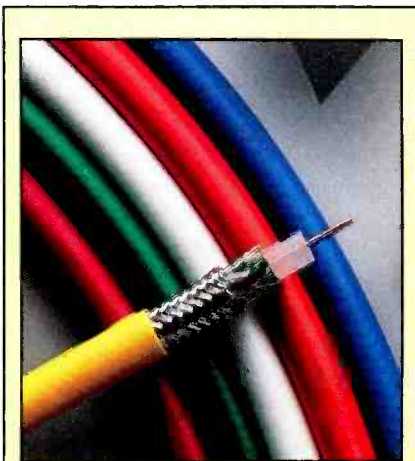

The photo credit for the November cover was inadvertently left off the table of contents. Our thanks to Belden Electronic Wire and Cable, Richmond, IN, for providing us with the November cover.

A mistake to disregard errors?

I read Sam Wilson's "What Do You Know About Electronics?—Thevenin's Theorem" in the October issue. I would like to give you my opinion on the next-to-last paragraph—"You make a bad mistake if you reject a book on the basis of a few errors."

If you're reading a book for an education, how do you know which are errors and which are not? It might take quite some time for a novice to realize an error has been made.

In my opinion, very careful editing of new book material is a must and is an obligation to the reader. After all, he's the one paying the bill and trying to learn. He shouldn't have to waste his time looking up errors. If he accepts the error and does not know it is an error, his mind is now impressed with this error as a fact.

Raymond McCoy
Fort Worth, TX

Dear Mr. McCoy:

In an ideal world, a new car comes off the assembly line with absolutely no problems, airplanes never crash and technical books have absolutely no errors. That is the world we strive for.

In the real world, there are errors and problems. We never get to the point where we accept them without complaint, but we don't let these things

bring us to a complete halt. People still buy cars, books and airplane tickets.

Your point about errors in books is well-taken. Certainly, the authors and editors must make every effort to get the errors out. In my experience, they do a good job. It is very rare to have a glaring technical error in an article or book.

Errors in spelling, punctuation or even math do creep in, however. Recently I saw a new book with Ohm's law written as $I=VR$. The printer had obviously left out the slant bar for the fraction. It should have been $I=V/R$.

That error should not bother the novice because the equation is written correctly a number of times in the book, and the only way you can get the answers given in the answer sheet is to use the correct equation.

It is not a good idea to get all of your learning from one source. By reading other sources, you will easily spot a minor error.

Sam Wilson

A warning for microwave servicers

I enjoyed the article in the October issue about microwave ovens by Donald Hopkins. He stressed the danger of the high voltage and its lethal current capability, but he didn't stress the nasty shock you can get if you don't properly discharge the capacitor in some ovens. This capacitor can hold a potential across both terminals, and discharging from one terminal to the other will still leave the potential to the case of the capacitor. I ran into this on an older commercial microwave oven. The shock I got produced a burn on my finger. I knew the capacitor had been discharged one terminal to the other, but shorting either terminal to ground after shorting one terminal to the other still produced a hot spark. Since that time, I always clip-lead my shorting bar to ground when I discharge the capacitor, and I never trust bleeder resistors to do that job.

Vic Hemmersbach
Morris, IL

Thanks for the safety tip. As you know, electronics servicing can sometimes be downright dangerous if you don't follow recommended safety procedures. A little extra caution never hurts. Shocks of this magnitude, however, can.

Editor

ES&T

Using a personal computer to Automate your service testing—Part I



By Gregory D. Carey, CET

Did you know that if you have a personal computer and test equipment with the appropriate interface hardware, you can hook it up to a consumer product that has an intermittent failure, go away, and have the computer store test values? With this setup, if the problem occurs while you're away, you can interrogate the computer and determine what the nature of the problem is.

The personal computer has more capability in electronic testing and servicing than most people realize. It can be connected to many test instruments to make some testing automatic. This article explains the two different methods of interconnecting a computer and test equipment. In Part II, which will appear in a future issue, we will cover some typical uses for this marriage.

The computer interface

There are two types of computer interface systems used to connect test instruments and computers: IEEE-488 and RS-232. The IEEE-488 format is also called the *general purpose interface bus* (GPIB) or the *Hewlett Packard interface bus* (HPIB). RS-232 is the standard serial interface used on many computers. The two interface systems have advantages for different uses.

Both approaches to computer interfacing let you connect a computer to external devices. Both are bidirectional, which allows the computer to either send information out or receive it back from the outside world. A few very expensive test instruments have both built-in, but by far most test instruments with computer interface have either one or the other, based on how the instrument will be used.

Carey, an application engineer at Sencore, has run more than 800 seminars for service dealers.

Test instruments with GPIB greatly outnumber those with RS-232. Several thousand test instruments are available with GPIB interfacing as an option. A few plotters and printers also use GPIB, but they usually are intended to be used in a system that already uses the GPIB format for test instruments.

By comparison, RS-232 is more common than GPIB in computers. Printers,

instruments that have RS-232 typically are those used for remote sensing, such as RF signal-strength meters.

Neither RS-232 nor GPIB is "ideal" for every instrument application. Each protocol works very well in some uses, marginally in others, and poorly in still others. Table 1 shows the relative advantages and disadvantages of the two protocols. Notice that the only advantage

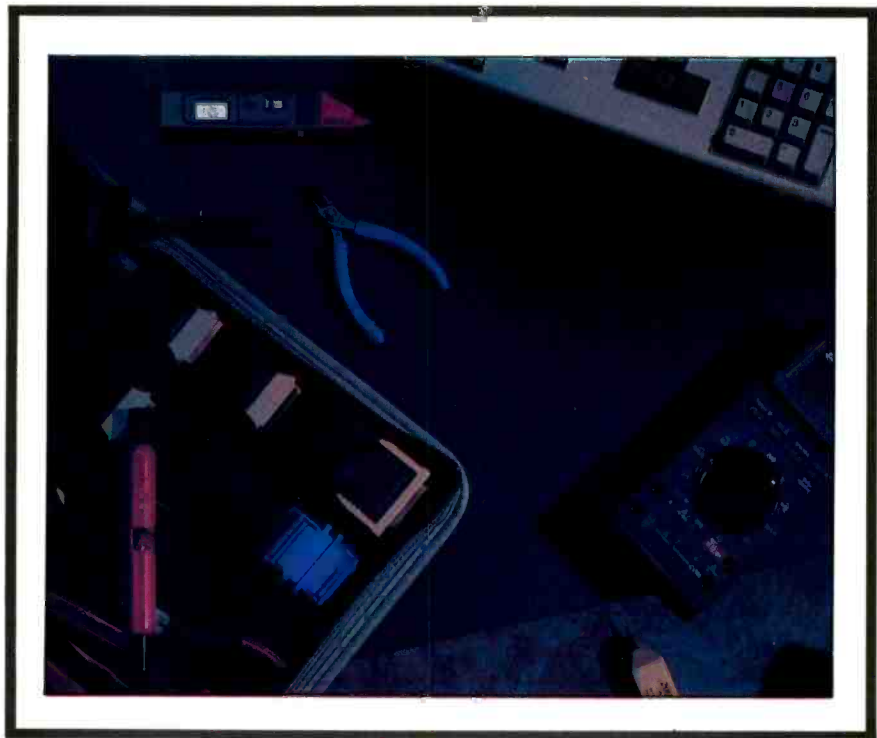

plotters, scanners and modems often use the *standard serial interface*, which is another name for RS-232. (Some printers use a third protocol known as the *Centronics parallel* standard. This parallel format is used when data flows in only one direction, from the computer to the printer.) The only test in-

common to both is the ability to move data in both directions. After that, the two look very different. The decision of which system is to be used for a particular application must be based on what the system needs to do. Because RS-232 is already built into personal computers, many users want to use it for

automation. Yet GPIB is the preferred protocol for most test equipment applications.

The biggest differences

Although it has several secondary advantages, RS-232's single biggest advantage is that it can easily send signals over longer distances. It can directly send signals about 1,000 feet in one run of cable. A device called a *line extender* lets the run go even farther. For example, many mainframe computers use RS-232 to send data to printers located in many locations of a business. Inexpensive twisted-pair cables interconnect the computer and printer.

If data must be sent over longer distances, a modem (a word meaning *modulator/demodulator*) can convert RS-232 signals into a form that can be fed over a standard telephone line. GPIB signals must first be converted to RS-232 if a modem is needed.

By contrast, GPIB's single biggest advantage is that it can work with several instruments simultaneously. This capability is essential when an automated test requires more than one item to be under computer control. For example, a manufacturer might use GPIB to automate several pieces of test equipment at the end of a production line. Up to 15 different units can be connected simultaneously when GPIB is used.

The reason for these differences is the way the signals are fed to and from the computer. RS-232 is a serial system, which means the ones and zeros of information must follow each other down a single wire, like a string of cars

through a tunnel. RS-232 uses two such wires: one leading from the computer out and one from the outside world in, allowing data to flow in both directions simultaneously. RS-232 standards also allow for 21 other wires to be used for various functions for controlling and supporting the two main signal lines.

GPIB is a parallel format. Eight separate wires carry the data into or out of the computer, allowing an entire byte (eight data bits) to move at one time. If all things were equal, this would make GPIB eight times faster than RS-232. (GPIB can actually transfer data about 260 times faster than the fastest RS-232 data rate because of other electrical differences in GPIB.)

One additional feature of the eight data lines is that they provide a standard way to address any of the external units, either one at a time or in groups, allowing connection of several units. RS-232 needs expensive or complicated mechanical or electrical signal switching to work with multiple instruments.

Availability of interfaces

RS-232 interface ports are either included as part of a personal computer or easily added with a low-cost accessory board. RS-232 will interface with many printers (RS-232 is sometimes called a *serial printer port*) and is the only standard that works directly with modems.

Third-party manufacturers make accessories to add GPIB to IBM and Apple Macintosh computers. Similar accessories were available for Apple II, Commodore and Radio Shack TRS-80

computers earlier, but most manufacturers have discontinued making these cards. Some specialized computers, such as those from Hewlett-Packard and Fluke, are designed as instrument controllers and use GPIB as their main input/output port.

Because RS-232 is common on computers but GPIB is often needed for test equipment automation, several manufacturers make devices called *protocol converters*. The computer connects to the RS-232 side of the converter, which, in turn, converts the signals to GPIB. These converters let you take advantage of the benefits of both communications protocols for even more versatility. (In the final installation of this 2-part series, we'll show some examples of using one of these converters.) The main advantages of a GPIB board inside the computer are higher-speed data transfer and fewer internal cables and boxes.

Both RS-232 and GPIB are based on industry-wide standards, but only GPIB is a true standard. RS-232 has hundreds of variations to make direct connection more difficult. Let's look at a few of these variations.

Various RS-232 schemes

The RS-232 standard specifies voltage levels and polarity so that one RS-232 feeds another directly. However, the many variations in RS-232 make it notoriously difficult to work with when you are connecting two devices for the first time. The difficulty comes from variations in data transfer rates, data formats and electrical connectors. Once

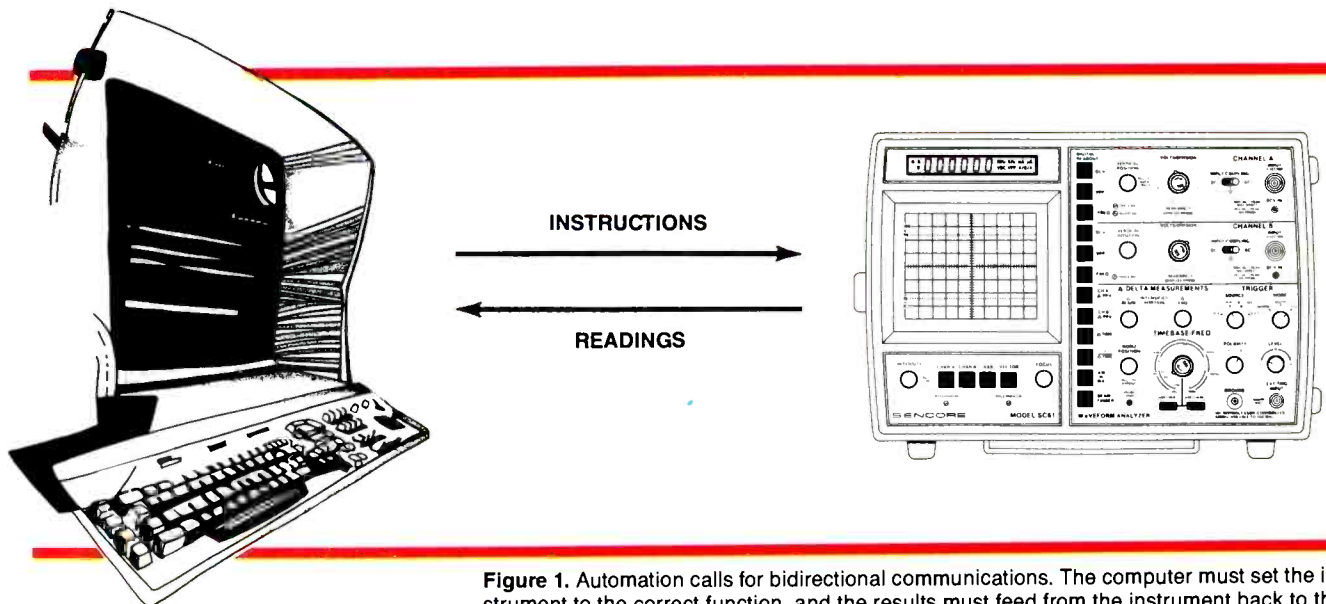

Figure 1. Automation calls for bidirectional communications. The computer must set the instrument to the correct function, and the results must feed from the instrument back to the computer.

PC Troubleshooting and Repair Products and Services

from

Windsor Technologies



PC-Technician

A complete family of diskette-based diagnostic systems for IBM PCs and compatible computers.

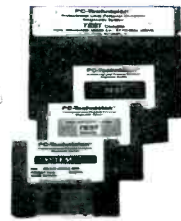

WindsorPOST

A family of unique ROM-based diagnostic products for service shop and repair depot.

Education and Documentation Services

Comprehensive standard or custom classroom-based computer repair and troubleshooting training, plus service documentation support.

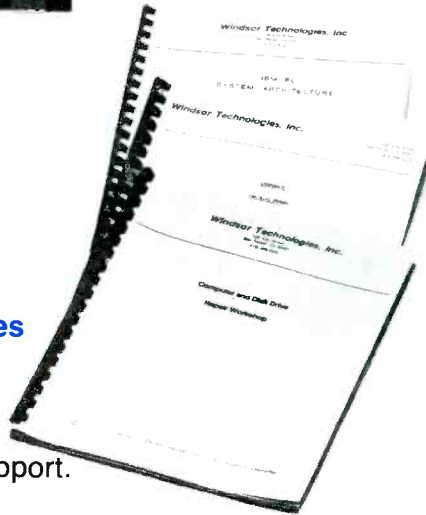

Windsor Technologies, Inc.

130 Alto Street,
San Rafael, California 94901
(415) 456-2200
FAX: (415) 456-2244

Circle (9) on Reply Card

PC-Technician and WindsorPOST are trademarks of Windsor Technologies, Inc., and IBM PC, PC XT, PC AT are trademarks of International Business Machines Corporation.

Mail to: **Windsor Technologies, Inc.**

130 Alto Street, San Rafael, CA 94901
(415) 456-2200; FAX: (415) 456-2244

Please send me the following:

FREE PC-Technician Evaluation Diskette:

IBM PC, PC XT, PC AT

IBM PS/2 Group

WindsorPOST information

Windsor Education & Documentation Services information

NAME _____ TITLE _____

COMPANY _____ TELEPHONE _____

ADDRESS _____

CITY _____ STATE _____ ZIP _____

SERVICE CO. OEM MANUFACTURER DEALER VAR/VAD

IN-HOUSE SERVICE USER OTHER _____

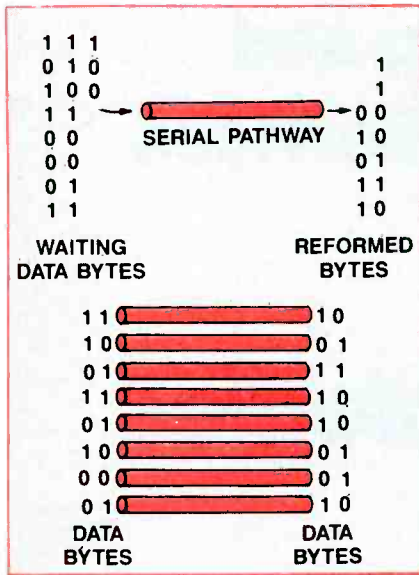

Figure 2. The serial RS-232 protocol must send data one bit at a time down the serial line; the parallel GPIB sends eight parallel bits at once.



All four of these connectors are used for RS-232, depending on the brand and model of computer. The 25-pin connector (far right) is used most often.



There is only one type of GPIB connector used. Most have a male and a female connector on each cable end, allowing the connectors to be stacked on top of each other.

you get it running, it generally works well from then on unless you add or change some part of the system.

First, RS-232 encompasses 15 different data transfer rates. The rate of data transfer is measured in *baud*. One baud is the transfer of one data bit per second. For example, a 300-baud device transfers data at 300 bits per second. It takes about 10 bits (seven or eight data bits plus two or three control bits) to form one character (byte), so the data transfers at one-tenth the baud rate. A baud rate of 300 yields about 30 characters per second, and the fastest RS-232 baud rate of 19,200 sends data at about 1,900 characters per second.

The computer and the external device must use the same baud rate to communicate. If the two rates are different, each character is garbled and all data are lost. Most RS-232 devices have switches, sometimes inside or on the back panel, that let you set the baud rate to match the computer system.

Aside from speed variations, there are nearly a dozen data format variations. Data bytes can either be seven or eight

bits long. RS-232 then adds extra pulses called *stop bits* and *parity bits*, which help ensure accurate data transfer. There can be one or two stop bits, and parity can be none, even, odd, mark or space for even more variations. The number of stop and parity bits must also match in order for data to move from one device to the other. Again, switches on the unit let the user match an instrument to the computer system.

Finally, RS-232 uses at least four different physical connectors with five, eight, nine and 25 pins. The 25-pin version has been the most common, but it has dozens of different wiring variations. Luckily, the main data and ground pins are always the same. Table 2 shows the four pins that are always the same.

The data-out and the data-in pins interchange, depending on whether you're considering the computer end or the other end of the cable. The "out" of the computer must feed the "in" of the external device and vice versa. There's a 50-50 chance that an RS-232 cable will connect the inputs and the outputs correctly. Some devices have switches or

Sources of GPIB interface products or software

Black Box
P.O. Box 12800
Pittsburgh, PA 15241
412-746-5530
(RS-232/IEEE-488 converters)

Connecticut microComputer
Box 186
Brookfield, CT 06804
800-426-2872
(RS-232/GPIB converters)

ICS Electronics
2185 Old Oakland Road
San Jose, CA 95131
408-432-9009
(RS-232/GPIB converters)

IOtech
Box 391344
Cleveland, OH 44139
216-439-4091
(RS-232/GPIB converters, IBM plug-in boards, Macintosh adapters, software)

MetraByte
440 Myles Standish Blvd.
Taunton, MA 02780
617-880-3000

(IBM plug-in boards, software)

National Instruments
12109 Technology Blvd.
Austin, TX 78727
800-531-GPIB
(RS-232/IEEE-488 converters, IBM plug-in boards, Macintosh adapters, software)

Scientific Solutions
6225 Cochran Road
Solon, OH 44139
216-349-4030
(IBM plug-in boards)

Tektronix
P.O. Box 500
Beaverton, OR 97077
800-835-9433
(IBM plug-in boards, software)

Wavetek San Diego
Box 85265
San Diego, CA 92138
619-279-2200
(Software)

Ziatech
3433 Roberto Court
San Luis Obispo, CA 93401
805-541-0488
(IBM plug-in boards, Macintosh adapters)

jumpers to let the user exchange the wiring of the "in" and "out" pins when the output of the computer connects to the output of the other device.

If there is no way to internally switch the pins, there are two solutions: custom wired cables or an adapter plug that reverses the connectors. This adapter plug is called a *null-modem*, *modem eliminator*, *cable switcher* or *line reverser*. The null-modem has a female connector on one side and a male connector on the other with the wires exchanged between them (pin 2 on one side connects to pin 3 on the other and vice versa). The null-modem also exchanges the pins used for the handshaking functions explained later.

GPIB standard connections

All GPIB connections and signals are the same. You can connect any GPIB device to any GPIB computer, and you can be confident the signals electrically match each other. If the two devices don't work with each other, the problem is in the software or in the device setup because there are no variations in the electrical performance.

GPIB does not need settings for baud rate, stop bits and parity bits because of its standard data format. The format uses the same pins for all data going to or coming from the computer. In addition, the system automatically adjusts its data transfer speed. GPIB can transfer data at any speed from less than one character per second to 500,000 characters per second, making it up to 260 times faster than an RS-232 system operating at 19,200 baud. Few instruments supply data that fast, but the system is capable of this speed without modification.

The GPIB connector, cable and signals are always the same. A standard 24-pin connector hooks one piece to the other, and the signals and connections are always the same, no matter which manufacturer made the unit. Each connector has both a male and a female connector, allowing them to be stacked on top of each other. Some systems may have every cable coming to a single point, forming a star arrangement; others may loop from one to the next forming a daisy chain. You can also mix stacking and chaining for any connection scheme you like.

There is a limit of about 2 meters per connection, however, which limits GPIB to short runs. Longer runs cause capacitive loading, which may cause

CHEMTRONICS ANNOUNCES

Ozone Safe

Freez-It[®]

fact: Freez-It[®], the electronic industry's most popular circuit refrigerant, is now available in an E-Series[™] formula with no ozone depleting CFCs.

fact: Superior thermal properties allow E-Series Freez-It to chill components faster and more economically.

fact: Consistent high purity, inertness and nonflammability with rapid cooling of components as low as $-96^{\circ}\text{F}/-71^{\circ}\text{C}$ provides positive diagnosis of thermal intermittents.

fact: New ozone safe E-Series Freez-It is available now only from Chemtronics.

For more information, contact Chemtronics at 800-645-5244 (in NY 516-582-3322).



 **Chemtronics**

681 Old Willets Path, Hauppauge, NY 11788

Circle (10) on Reply Card

January 1989 *Electronic Servicing & Technology* 21

Table 1
RS-232/GPIB comparison

ADVANTAGES	RS-232	GPIB
Bidirectional data transfer	X	X
Works with long cables	X	
Sends data by phone	X	
Included in most computers	X	
Inexpensive cables and connectors	X	
Controls one to 15 units		X
Fast data transfer		X
Standard to most test equipment		X
Automatically adjusts speed		X
Plug-together compatibility		X
One standard connector		X
Advanced software available		X
DISADVANTAGES		
Only controls one unit	X	
Speed of computer must match controlled unit	X	
Many data formats	X	
Many wiring variations	X	
Several connector styles	X	
Higher cost to add		X
Short cable runs only		X
Expensive multiconductor cable		X

distortion of high-speed data.

Handshaking

There must be some method for the external device to tell the computer to temporarily halt its data transfer if the device is busy doing something else. Similarly, the computer must halt incoming data if it cannot immediately

Table 2
Four standard pins of the RS-232 connector

FUNCTION	PIN
Safety ground	1
Data out	2 or 3
Data in	3 or 2
Data ground	7

process the information. *Handshaking* provides a means to properly control data transfer. If handshaking is not used (or is not timed correctly), individual characters of data will be lost. In extreme cases of poor handshaking, hundreds or thousands of characters may disappear.

GPIB takes care of handshaking with a single, standard method, so there is really nothing to consider in the design of a unit—it either meets GPIB standards and works, or it doesn't. RS-232 uses two methods of handshaking, with variations on each.

Transferring data by telephone calls for a method of handshaking that can be encoded on a standard phone line. The only method that works here is software handshaking. In this mode, the indicators to start and stop data transfer are sent as special characters with the other data. The most commonly used software handshake is called the X-ON/X-OFF (also called the DC1/DC3) system. Sending a special character (called a Control-S) to the device sending data causes it to stop. Sending another special character (a Control-Q) causes it to start again.

A second, less common system is called the ETX/ACK protocol. This is a complex system that eliminates the need for the sending device to constantly monitor the returning line for a busy signal. It is often used when data is sent between mainframe computers. The data are grouped into blocks with the same number of characters. Control characters embedded with the other data mark the end of blocks. The receiving device must be able to store entire

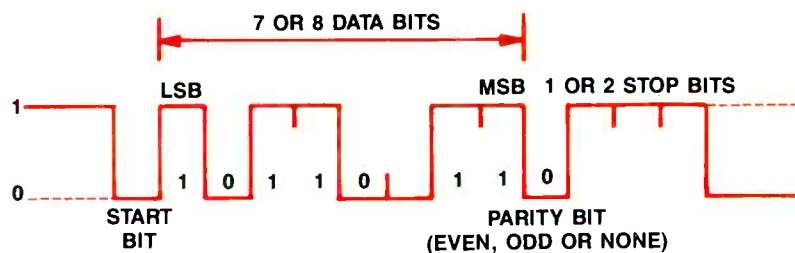

Figure 3. The computer and the external device must have identical data formats for them to communicate with RS-232.

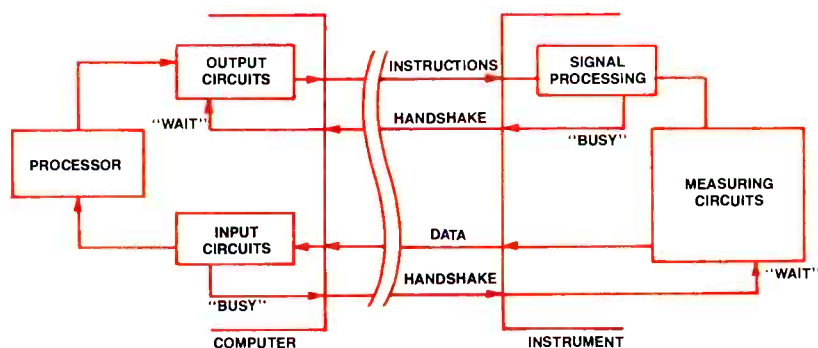

Figure 4. The handshaking signals halt the data flow if the device at either end of the cable is busy. Both RS-232 and IEEE-488 use handshaking.

blocks of data until it can be processed.

RS-232 systems that don't involve modems might use software handshaking or a hardware handshaking system. With hardware handshaking, two more wires connect between the computer and the external device. One signals the computer to stop sending characters if the external device is busy; the other serves the same function in the opposite direction.

Several pins are used for hardware handshaking. The most common are pins 6 and 20. Others, however, might use pin 11 or 19; still others use pins 4 and 5 for different handshaking purposes.

A breakout box is a special tester with lights that show which pins are active when an RS-232 system is connected. This tester often saves time when a device is first connected to a computer. After the connections have been deter-

each task. Because every application is different from every other one, this program was custom written for each specific job. The program can be written in BASIC, FORTRAN, PASCAL or machine language. Complex tasks often need involved programs.

This problem is now being overcome by several companies who are selling software that, in effect, writes software. The user enters the codes needed by each automatic instrument. (For example, the Sencore SC61 has 11 different

functions that the computer can choose.) The purchased program then puts the final software together after the user answers several questions on the computer screen. The purchased software then looks up the specific codes needed for each instrument and prepares software that does the needed tests.

This generation of computer programming greatly reduces the need to have highly skilled programmers on staff. Once installed in the computer, the programming becomes as simple as fit-

New units extend RS-232 uses

The biggest advantage of IEEE-488 compared to RS-232 is its ability to control more than one unit at the same time. An innovation by Connecticut micro-Computer brings RS-232 closer to GPIB abilities.

The new system, called CMCNET II, lets one RS-232 computer port control up to 40 devices. If more than 40 devices are needed, each of the 40 devices can control up to 40 more devices for a theoretical limit of 1,600 devices.

An adapter (priced about \$50) connects to the computer's RS-232 port, and different adapters (priced about \$200 each) connect to each controlled unit. The device on each unit has an addressing scheme similar to IEEE-488 to let the computer work with each unit in turn. Each unit adapter has its own microprocessor and buffer memory, which converts the baud rate of the computer to the baud rate needed by each unit. Systems like this may make RS-232 even more useful for test equipment in the future.

mined, the breakout box is removed and a cable is connected in its place.

Software considerations

Before you can automate a system, you must have a computer program that will do the necessary job. This specification once required someone to write a different computer program for

THE NEW OLD FAITHFUL.



Generations of engineers and technicians have come to depend on the reliability, accuracy and versatility of the Simpson 260 VOM.

Now Simpson introduces the new 260-8, with even more features than its predecessors. Like increased voltage measurement resolution. A mirrored scale on all units for parallax reduction. Or continuity tone for hands-free operation.

Try the Simpson 260-8. The tradition of yesterday. The features of today.

SIMPSON

853 Dundee Ave., Elgin, IL 60120 312/697-2260 FAX: 312/697-2272

Circle (11) on Reply Card

January 1989 *Electronic Servicing & Technology* 23

What automation can do

What can you do with test equipment after connecting it to a computer? There are three general uses of computer controlled instruments: data gathering, automatic testing and guided-probe testing. All depend on the correct software to control the instruments. The first two applications are available today and require moderate computer programming skills. The third is used by some large corporations and government agencies today and may find its way to other areas as personal computers gain in power.

Data gathering

This application can often be accomplished with a computer and a single instrument. The computer collects dozens or hundreds of readings until some event happens. This event may be a preset length of time or the occurrence of some condition at a test point, such as exceeding a preset voltage or dropping below a preset voltage.

For example, intermittents may be tested this way. Every reading from one or two test points may be stored in the computer. Because the computer's memory is not infinite, when the memory storing these values becomes full, it will discard the first item stored in order to make room for the next item coming in.

Here's an example of how testing automation can help in problem diagnosis. You can set the system up so that, when the circuit voltage being monitored drops below a preset value, the computer will stop gathering data and hold the readings it has taken up to that point. Then, at any time in the future, you can play back the previous 100 readings to examine the behavior of the parameter being measured just before the unit malfunctioned. It can also record the time of day the fluctuation happened and other conditions such as the line-voltage level at that time.

Another use for data gathering is extended performance testing. For example, the audio output power of a stereo amplifier can be recorded for an hour to show that it does not drift as the circuit warms, or an MATV amplifier can be tested for a 24-hour period to confirm that the signal levels remain constant.

Automatic testing

The computer performs a number of tests that are difficult to perform manually. The computer may control several test instruments such as power supplies, generators, meters and frequency counters to perform the test. For example, an audio amplifier can be

automatically tested for power output, frequency response and separation. The data can then be printed for the customer to show that the unit meets original specifications.

Another possibility is a diagnostic test that can be made before repairs, just as computers are used to test automobiles in service centers. This test tells the customer what needs to be fixed and also gives the technician a head-start.

Guided-probe testing

Fully automated diagnostic testing is still a dream for most people. The computer directs the operator to connect to a test point. Based on that reading, it determines which test point needs to be tested next. After several tests, the computer determines which stage or component is defective.

This method is currently used by a few governmental agencies and a few large manufacturers who service thousands of identical units or circuit boards. The limitation is the extremely complicated computer programs needed to do the job correctly. A breakthrough in computer software development is needed before this level of automation comes to the general servicer. However, the future may hold just such a breakthrough.

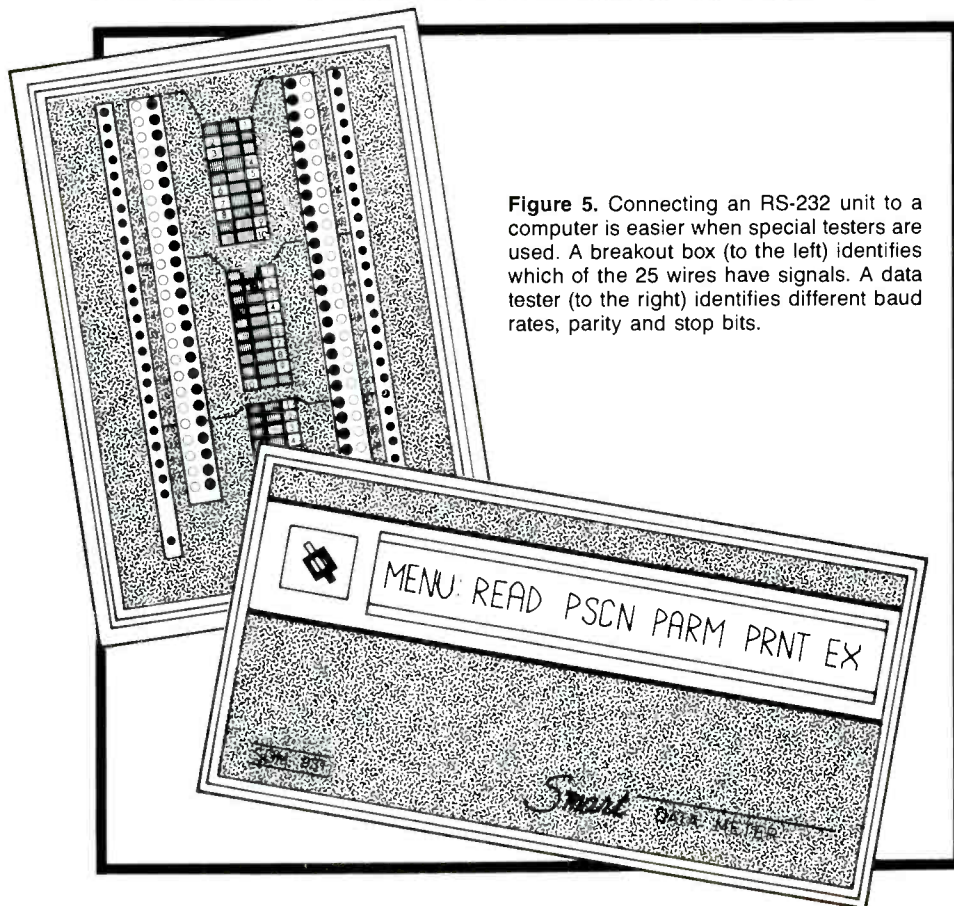

Figure 5. Connecting an RS-232 unit to a computer is easier when special testers are used. A breakout box (to the left) identifies which of the 25 wires have signals. A data tester (to the right) identifies different baud rates, parity and stop bits.

ting graphic symbols together on the screen. This may be the breakthrough needed to bring automation out of the factory and design lab and into the smaller company, such as a servicing organization.

This type of software is more common for GPIB than for RS-232. It is available for the IBM-compatible computers and Apple Macintosh systems. Once installed, it can be operated by someone with minimal training about computers.

Both RS-232 and GPIB will continue to exist in the computer and instrument world. RS-232 is needed whenever measurements must be taken from a distance. It also lets the average computer owner add testing automation with minimum investment because the computer probably already has an RS-232 connector. GPIB interfacing is used for any application needing more than one instrument. The new advanced GPIB software will make it easier for the average user to put together sophisticated programs, even if there is not a skilled programmer available.

ES&T

Samsung CT-501AL
Photofact 2055

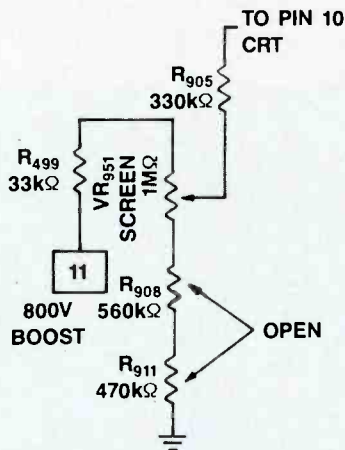

Symptom: Bright screen with heavy retrace lines.
Cure: Replace R_{908} or R_{911} .

Samsung CT-501AL
Photofact 2055

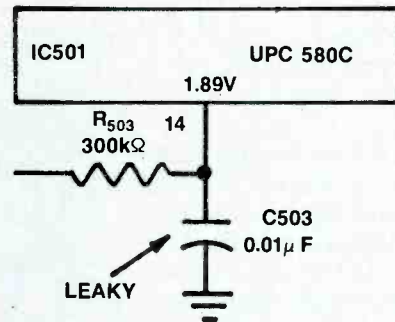

Symptom: No color, voltage low on pin 14, IC501.
Cure: Replace leaky C_{503} .

Samsung CT-501AL
Photofact 2055

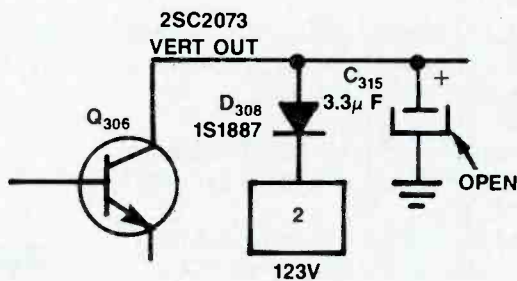

Symptom: Insufficient height with retrace lines at the top of the picture.
Cure: Replace open C_{315} .

Samsung CT-501AL
Photofact 2055

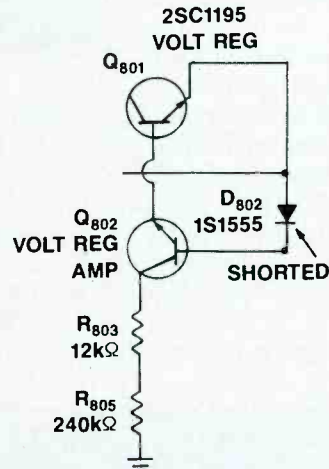

Symptom: Picture pulled in on sides.
Cure: Check for shorted D_{802} .

Samsung CT-501AL
Photofact 2055

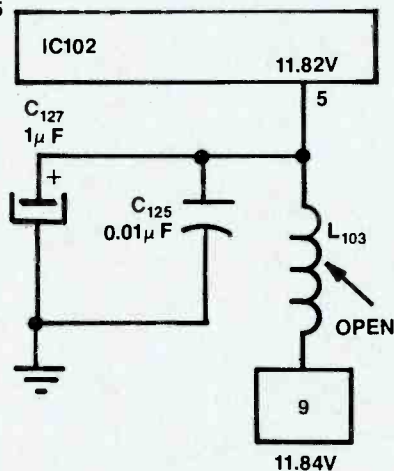

Symptom: Has high voltage and raster but no video and no audio. Voltage at pin 5, IC 102 measures 4.5V.
Cure: Replace open L_{103} .

Samsung CT-501AL
Photofact 2055

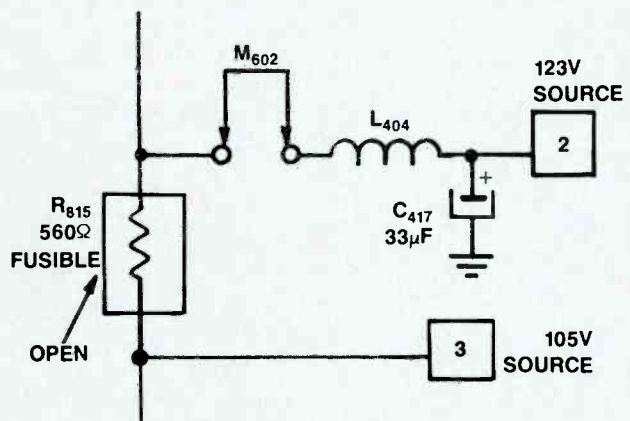

Symptom: No sound.
Cure: Check R_{815} . Replace if open. Also check for shorted Q_{603} .

Troubleshooting Tips

Symptom: No raster
Set ID: Magnavox 19C120A
Sams Photofact: 2376-2

As received, this set had high voltage and audio but no raster. The master screen control was turned up, showing only a thin horizontal line, which initially indicated a lack of vertical sweep.

The first things checked were the two vertical output transistors. Although dc voltages on them suggested that one or both might be bad, they proved to be normal. The coupling capacitor (C_{229}) was also checked, as well as C_{227} , but both of these capacitors were also good. R_{200} did seem to be operating quite hot, but I ignored this symptom at first. That was a mistake.

Next, I injected a vertical signal at the base of the vertical driver transistor, Q_{202} , which resulted in the return of vertical sweep. This cleared everything after IC200, leading to the suspicion that the problem might be the IC or that one of the inputs might be absent. One thing revealed by injection of the vertical sweep signal was that there was also no video.

Checking the voltages at the pins of

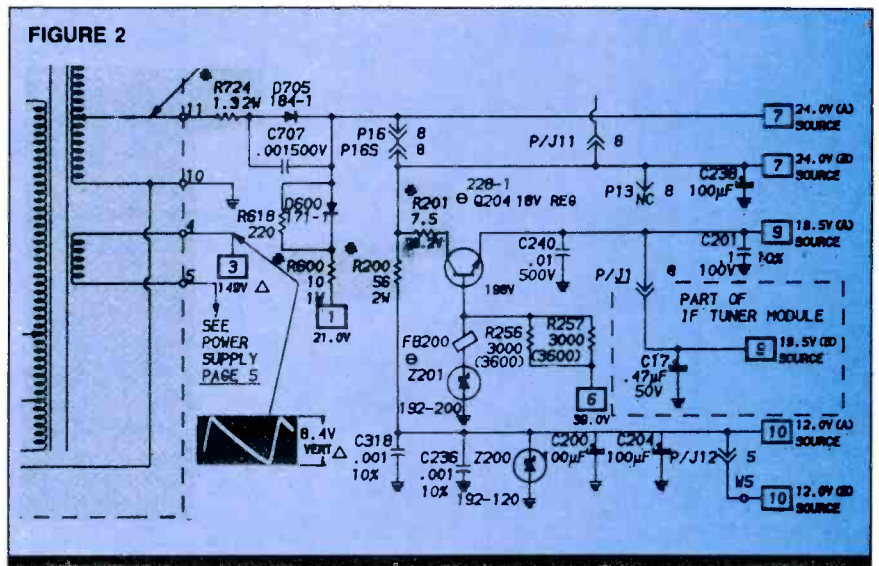

IC200 revealed that pin 18 had a voltage of only 1.25V, although it was specified to be at 12V. Tracing this voltage back to its source showed that the voltages at the regulator, Q_{204} , were correct, but somewhere along the line something was causing it to drop.

Further checking revealed that zener diode Z_{200} was shorted. This short was

causing R_{200} to overheat. Replacement of Z_{200} restored the set to proper operation.

Michael B. Danish
Aberdeen Proving Ground, MD

Steven D. Ashcraft
Edgewood, MD

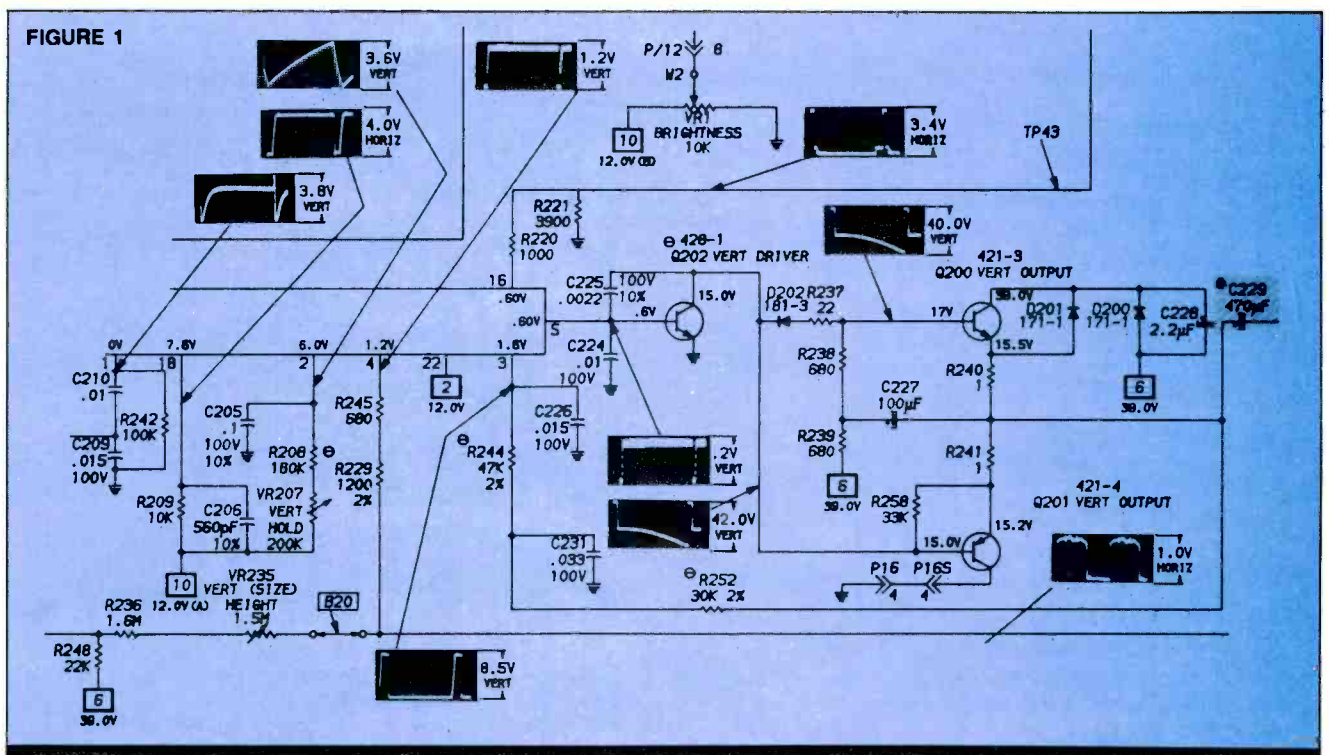

Books/Photofact

Microprocessor Digest; D.A.T.A. Business Publishing; 544 pages; \$110 for annual subscription, \$60 for quarterly updates (total annual subscription, including three quarterly updates, \$170).

This digest describes more than 16,000 devices from more than 110 manufacturers. Information covered includes pinout information; product information by function, technical characteristics, generic part number and specific manufacturer part numbers; the most valuable electrical parameters for every part number covered; packaging information; identification of discontinued devices; and alternate sources and replacements for all listed devices.

D.A.T.A. Business Publishing, 9889 Willow Creek Road, P.O. Box 26875, San Diego, CA 92126; 619-578-7600.

The Cellular Telephone Installation Handbook, by Michael Losee; Quantum Publishing; 237 pages; \$49.95 plus \$3 shipping.

This step-by-step guide teaches the latest and most effective installation, troubleshooting and repair techniques. The book explains antenna theory, selection, placement and installation and includes complete sections about cellular system theory; test equipment and tools; telephone selection, placement and installation; and marine and rural installations.

Quantum Publishing, Box 310, Mendocino, CA 95460; 707-937-4488.

Microcomputer Troubleshooting & Repair, by John G. Stephenson and Bob Cahill; Howard W. Sams; 354 pages; \$24.95.

This book describes the nuts-and-bolts reality of microcomputer equipment and provides a practical approach to computer troubleshooting and repair. The beginner can learn how to do simple repairs and how to determine whether to call a repair shop. The electronics student can get an introduction to troubleshooting, including the tricks and shortcuts the pros use.

Howard W. Sams & Company, 4300 W. 62nd St., Indianapolis, Indiana 46268; 800-428-SAMS.

Learning Electronics: Theory and Experiments with Computer-aided Instruction for the Apple, by R. Jesse Phagan and Bill Spaulding; TAB Books; 370 pages; \$16.60

paperback, \$24.95 hardbound.

This book combines theory, hands-on practice and computer exercises to make this book suitable as a student text or a home self-teaching guide for hobbyists. The authors assume no special knowledge on the part of the reader—engineering notation, basic math, instrumentation principles, soldering

techniques, terminology, tools, magnetism and more are covered. Quizzes and two exams allow students to assess their progress, and computer programs for almost every chapter are included.

TAB Professional and Reference Books, Blue Ridge Summit, PA 17294-0850; 717-794-2191.

ES&T

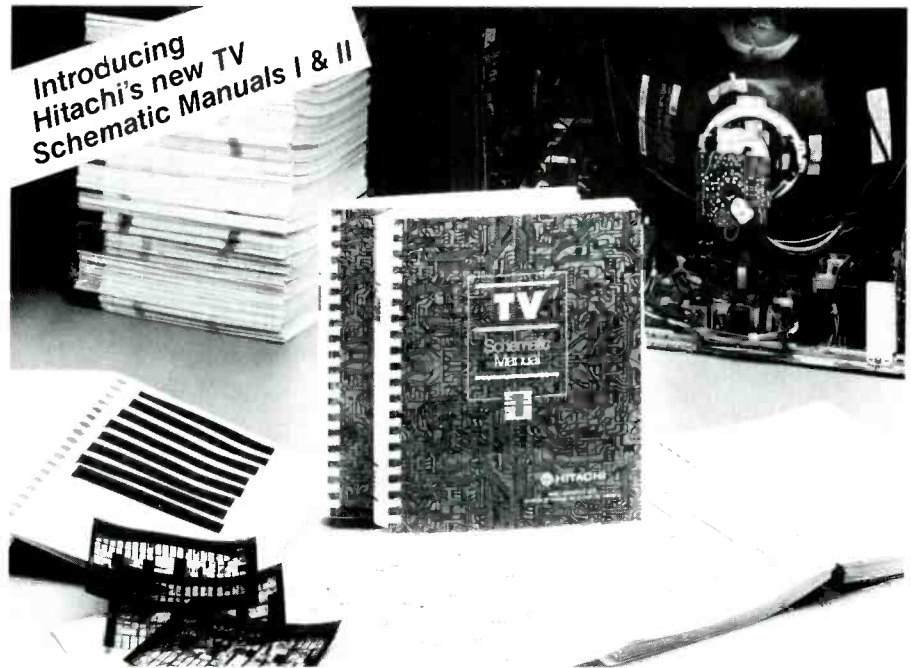

All the technical data of 83 Hitachi TV Manuals—in just two volumes



Our new Hitachi TV Schematic Manuals give you the best of both worlds—

With the compact storage of 32X microfiche and full-view hard copies of the items you use the most. Organized by year and model number in both formats, these volumes give you everything you need—83 models from 1975–1981. They're neatly packaged, easy to use, and economically priced.

You'll get hard copies of:

- Schematic Diagrams • Block Diagrams
- Printed-Circuits Board Layouts • Part Lists • Mechanical Part Exploded Views

And get the works on microfiche:

- Service Manuals with Technical Data and Information • Troubleshooting Tips • Revised or Supplemental Manuals • Instruction

Manuals • Parts and Service Bulletins

Volume I covers: 54 models from 1975–1978.

Volume II covers: 29 models from 1979–1981.

That's a lot of service data for a low **\$54.95** per volume! About what you would expect to pay for information on only two models. Or save even more by getting both volumes for just **\$104.00**. Take advantage of these savings now. It's a simple, cost-effective way to increase proficiency and increase profit. Also available are our VCR Volumes I, II and III.

Call toll-free 1-800-447-2882 for your nearest Authorized Hitachi Distributor

HSC Service Company

division of Hitachi Sales Corporation of America

Circle (12) on Reply Card

January 1989 *Electronic Servicing & Technology* 27

Test your electronics knowledge

By Sam Wilson, CET

Most of the subjects in this quiz have been covered in previous quizzes, so you should be able to get a grade of 70% or better. It is the fill-in answers (rather than multiple choice) that make the test difficult.

- To increase the frequency of the output signal in the circuit in Figure A, move the arm of R
 - toward the end marked A.
 - toward the end marked B.
- The electronic component used for switching in the circuit in Figure A is marked with an X. What is the

Wilson is the electronics theory consultant for ES&T.

name of this component?

- Which of the following components could be used in place of X in the circuit in Figure A?
 - a neon lamp.
 - a zener diode.
 - either could be used.
 - neither could be used.
- Draw the waveform of the output signal for the circuit in Figure A.
- What 2-terminal component is represented in Figure B?
- Draw the symbol for the component represented in Figure B.

7. The tiny component in Figure C is made of ferrite. What is it used as?

- If the component in Figure C doesn't quite accomplish its task, you would
 - increase the size of the component.
 - use two instead of one.
- What do the initials HDTV stand for?
- What do the initials TVRO stand for? (Used in satellite receiver systems.)

Answers are on page 41.

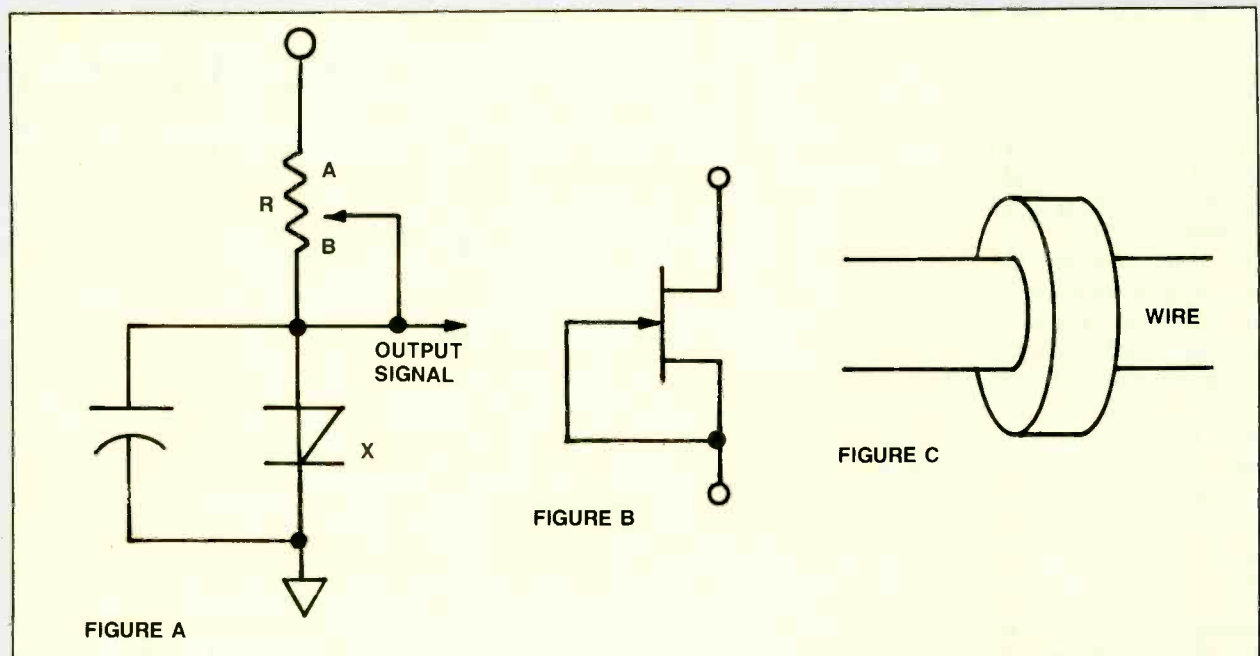

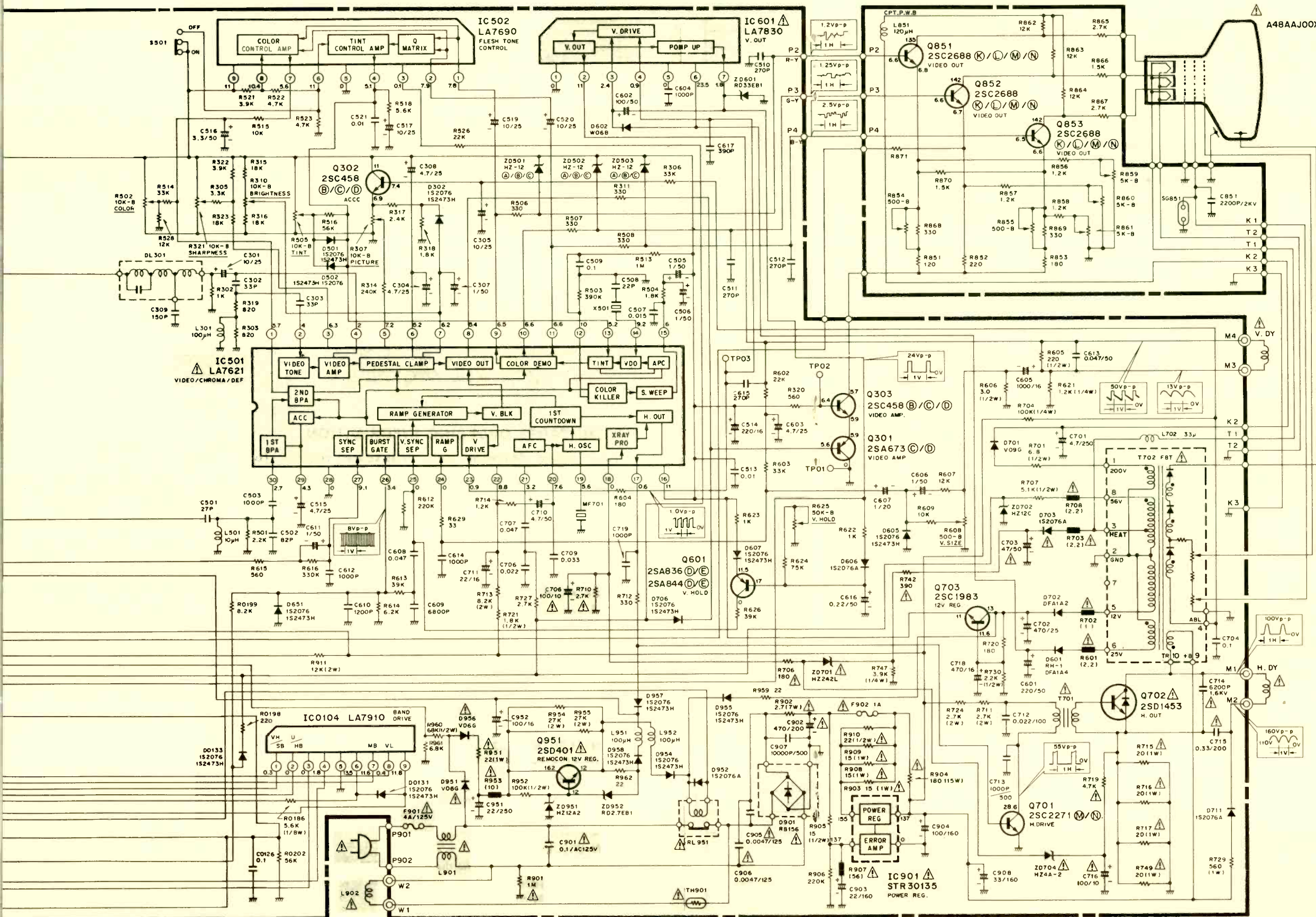

Product safety should be considered when component replacement is made in any area of a receiver. Components marked with a ! and shaded areas of the schematic diagram designate sites where safety is of special significance. It is recommended that only exact cataloged parts be used for replacement of these components.

Use of substitute replacement parts that do not have the same safety characteristics as recommended in factory service information may create shock, fire, excessive x-radiation or other hazards.

This schematic is for the use of qualified technicians only. This instrument contains no user-serviceable parts.

The other portions of this schematic may be found on other Profax pages.

HITACHI CT1955, NP85XA CHASSIS

HITACHI CT1955, NP85XA CHASSIS

Product safety should be considered when component replacement is made in any area of a receiver. Components marked with a ! and shaded areas of the schematic designate sites where safety is of special significance. It is recommended that only exact cataloged parts be used for replacement of these components.

Use of substitute replacement parts that do not have the same safety characteristics as recommended in factory service information may create shock, fire, excessive x-radiation or other hazards.

This schematic is for the use of qualified technicians only. This instrument contains no user-serviceable parts.

The other portions of this schematic may be found on other Profax pages.

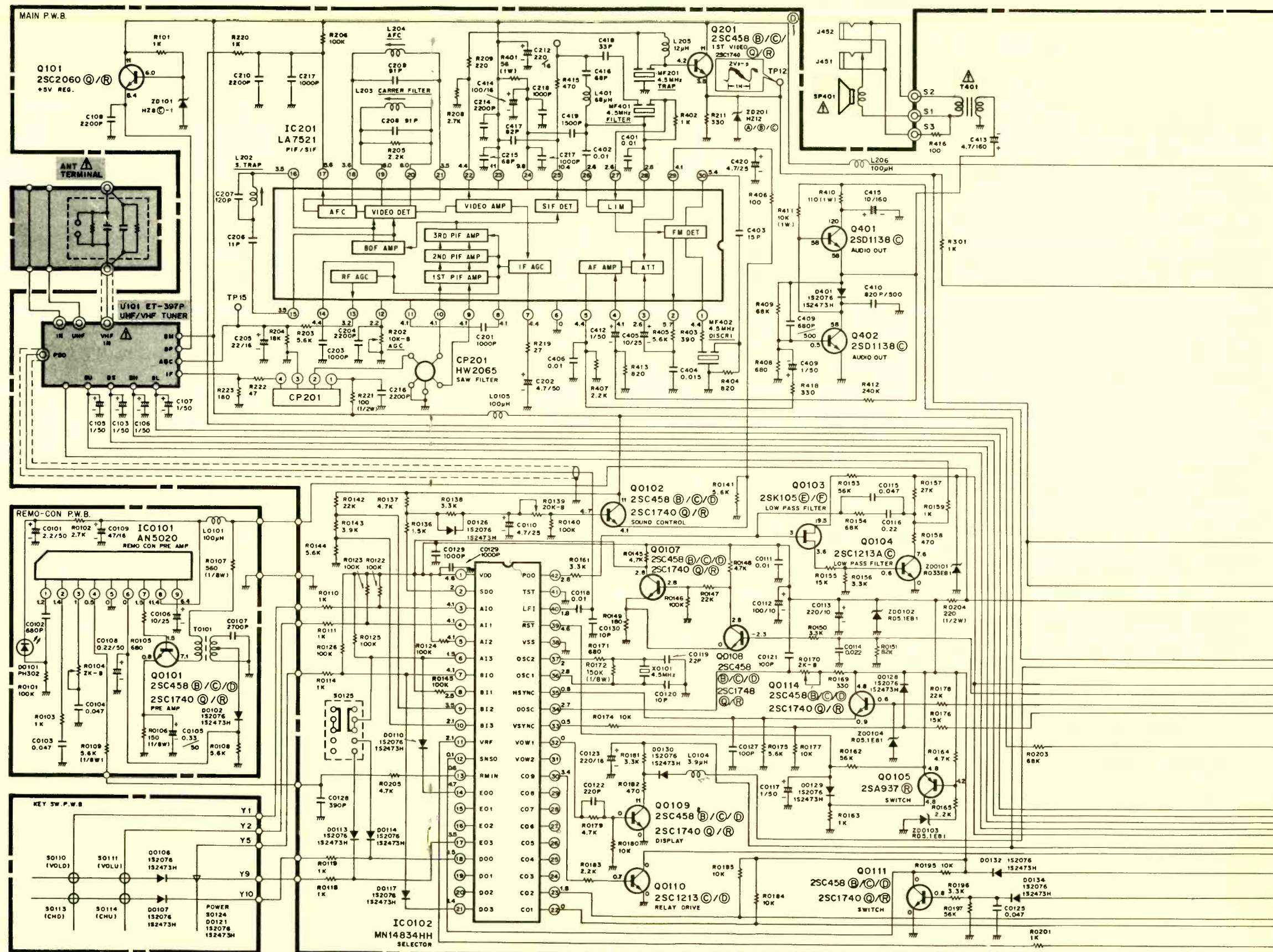

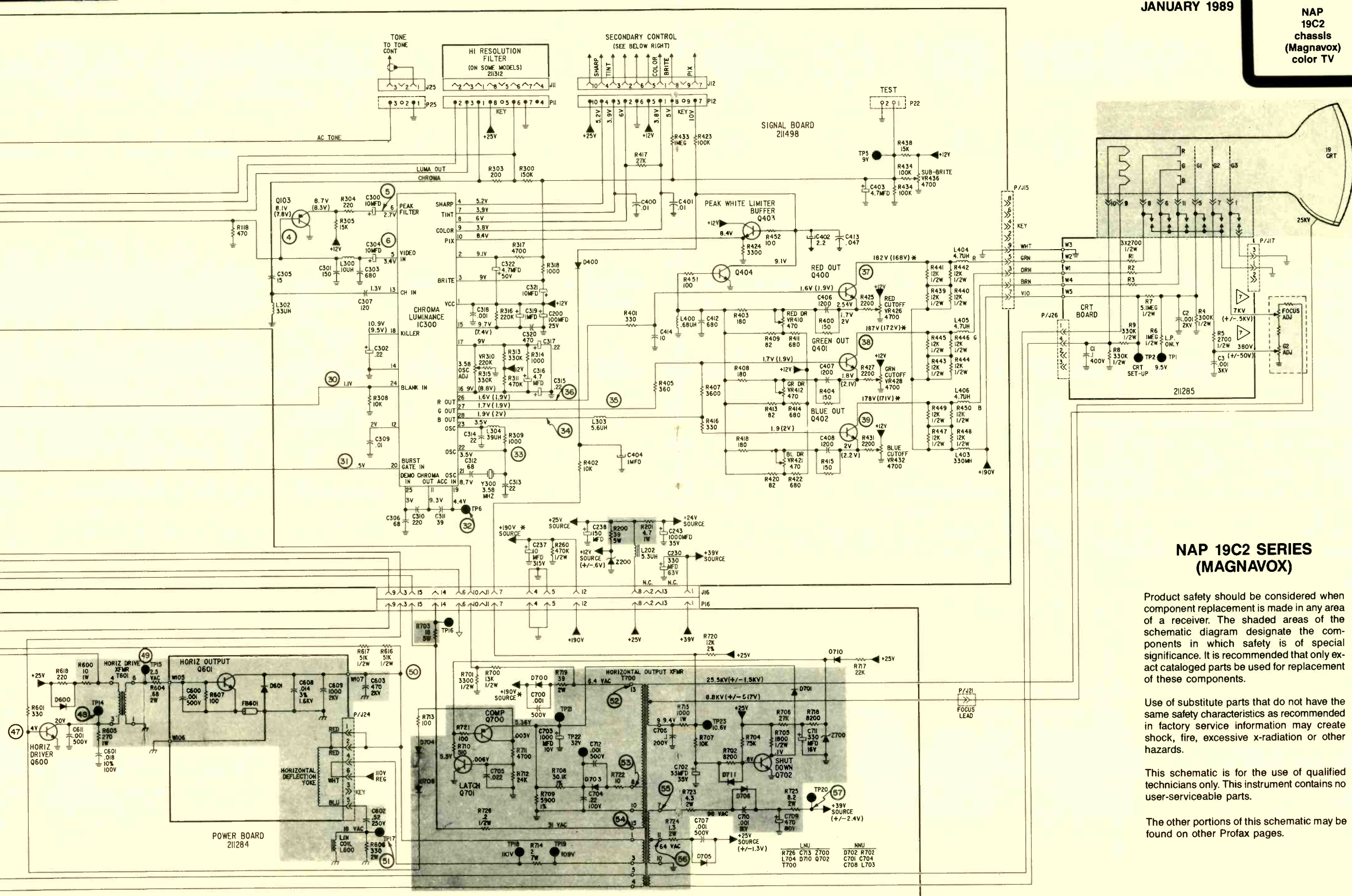

NAP 19C2 SERIES (MAGNAVOX)

Product safety should be considered when component replacement is made in any area of a receiver. The shaded areas of the schematic diagram designate the components in which safety is of special significance. It is recommended that only exact cataloged parts be used for replacement of these components.

Use of substitute parts that do not have the same safety characteristics as recommended in factory service information may create shock, fire, excessive x-radiation or other hazards.

This schematic is for the use of qualified technicians only. This instrument contains no user-serviceable parts.

The other portions of this schematic may be found on other Profax pages.

NAP 19C2 SERIES (MAGNAVOX)

Product safety should be considered when component replacement is made in any area of a receiver. The shaded areas of the schematic diagram designate the components in which safety is of special significance. It is recommended that only exact cataloged parts be used for replacement of these components.

Use of substitute parts that do not have the same safety characteristics as recom-

mended in factory service information may create shock, fire, excessive x-radiation or other hazards.

This schematic is for the use of qualified technicians only. This instrument contains no user-serviceable parts.

The other portions of this schematic may be found on other Profax pages.

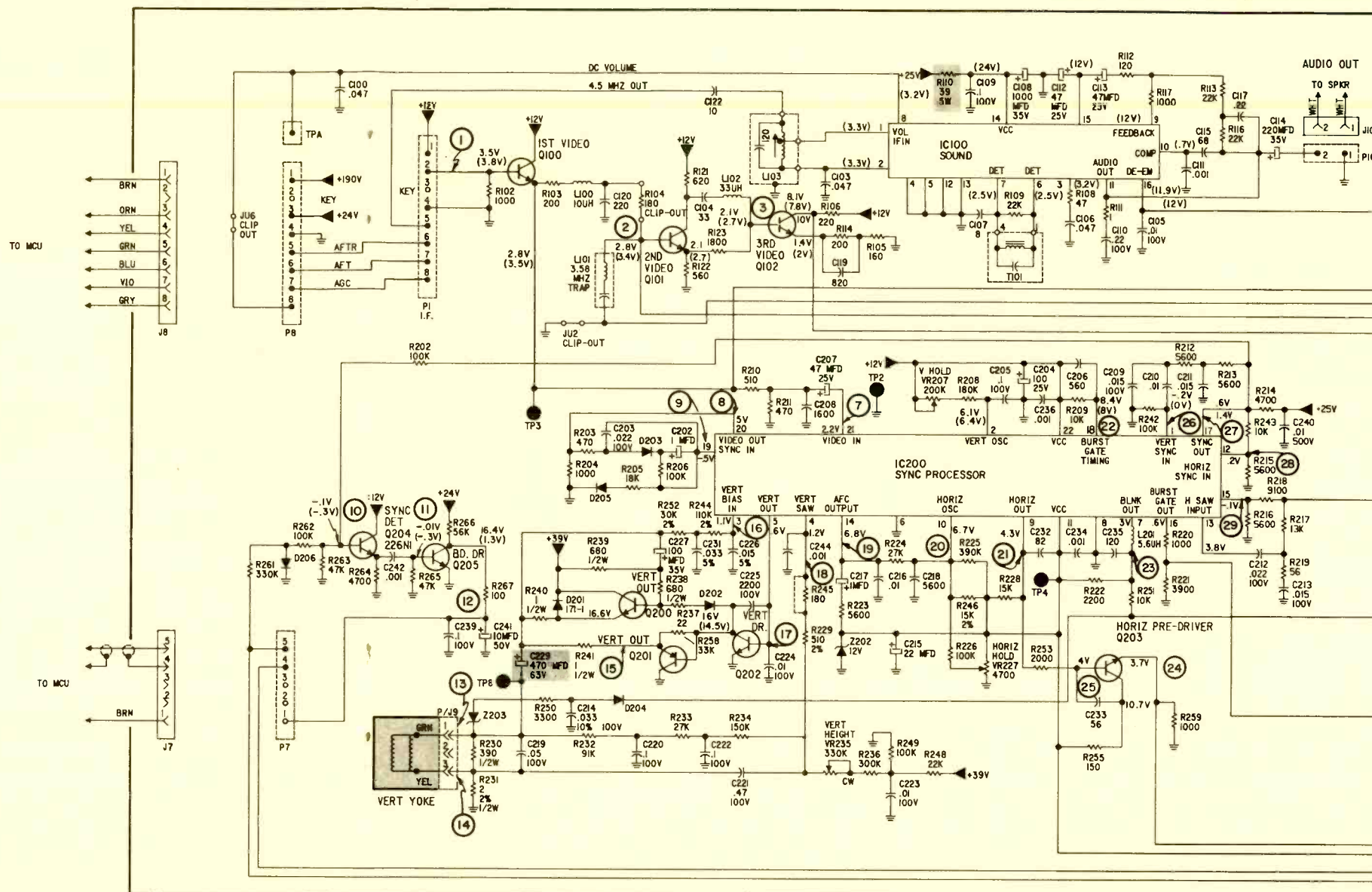

NOVEMBER 1988

SCHEMATIC

Hitachi CT1955 color TV, NP85XA chassis color TV.....3038

NAP Series 19C2 chassis (Magnavox) color TV.....3036

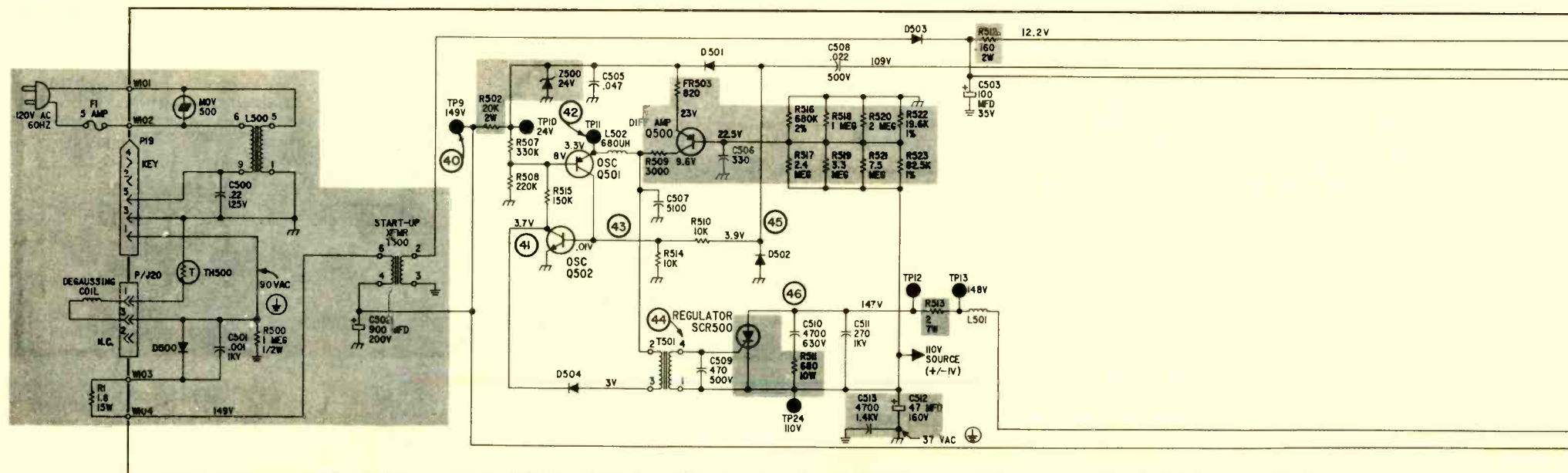

Answers to the quiz

Questions are on page 28.

1. A—toward A. You want to decrease the time constant (by decreasing the resistance) in order to decrease the time for each cycle. Decreasing the time for each cycle increases the frequency ($f=1/T$).
2. A 4-layer diode. It will not conduct until the voltage across it has reached a predetermined value called the breakover voltage.
3. A—a neon lamp. When the breakover voltage is reached, the operating voltage must drop to a lower value as shown in Figure D. (Only the first quadrant is shown in this illustration.)
4. See Figure E.
5. A constant-current diode. It conducts the same amount of current regardless of the amount of current through it (within the manufacturer's specifications).
6. See Figure F.
7. An inductor. The component is a ferrite bead. It acts like an inductor and is used to eliminate parasitic oscillations.
8. B—Using two is the same as connecting two inductors in series.
9. High-definition TV.
10. Television—receive only.

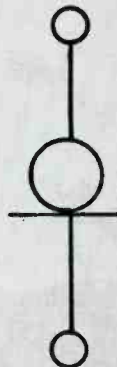
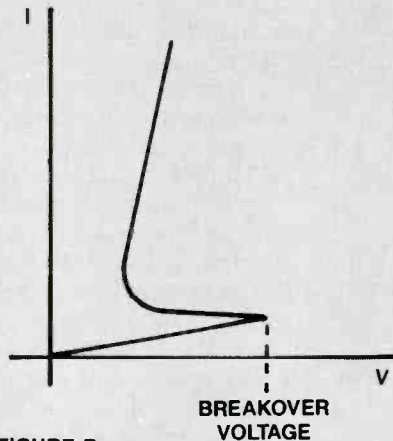

One case for all your needs . . .
files and paper, tools and parts
. . . samples and briefcase

THE 2X1

CASE SERIES FITS ALL YOUR NEEDS



With and without parts boxes, this is the fast-selling, great utility, **CORDURA® CARRYING CASE SERIES**. Innovative, new, designed especially for professional executives and technicians. So many features: soft handle for easy carrying, double/lockable zippers and pockets inside and outside; sturdy; attractive; with unique options.

Two models to purchase; one includes compartmented parts box for components, fuses, parts, etc.

Get the facts on **THE 2X1 CASE SERIES** from your manufacturers' sales representative or, communicate with us for informative, colorful, sales literature.



Chicago Case Co.

4446 S. Ashland Avenue, Chicago, IL 60609
(312) 927-1600 FAX: (312) 927-2820

Circle (16) on Reply Card

Servicing Sharp's small color TVs—Part II

By Homer L. Davidson

Although servicing a small-screen color receiver is quite similar to servicing its large-screen counterpart, the tight quarters inherent in miniaturization can cause special problems and slow down your troubleshooting. To buy back that extra time, you need to have a good idea what to check with a particular symptom *before* you open up the receiver.

Davidson is the TV servicing consultant for ES&T.

Part I, which appeared in the December 1988 issue, described basically how Sharp's small-screen TVs work. In Part II, we'll get into the specifics—what tends to go wrong and how you should approach certain problems.

No raster—normal HV and sound

When there's no raster, check the high voltage, screen voltage, focus voltage and video circuits. If the high voltage

is normal, check the video circuits and the picture tube.

One 9H102 H5-chassis Sharp portable had no raster but nearly normal HV. The focus and screen voltages measured very low. The schematic showed that both voltages are developed inside the horizontal-output transformer, and both adjustment controls are integral parts of the T₆₀₂ horizontal flyback, as shown in the photograph (to the right).

Installation of a new T₆₀₂ flyback transformer restored the high voltage and provided a normal picture. If a flyback must be removed in this model, desolder flyback connections on the circuit board and take out the side mounting screws that hold the flyback to the metal panel.

Insufficient height

Perhaps because much of the 9H100 vertical-deflection circuit is out of sight (inside IC801), the circuit is more difficult to analyze. The following brief description of the circuitry (see Figure 5) and its operation should be helpful during troubleshooting.

IC801 terminals 26 through 31 and the many components connected to them comprise the total vertical-deflection system except for the two vertical-output transistors, their necessary small components and the deflection yoke.

Vertical sync enters IC801 at terminal 31. The vertical-oscillation frequency is determined by a time constant set by the circuit consisting of the 0.22 μ F C₅₀₄ in conjunction with the total resistances of the R₅₀₅ vertical-hold control (maximum 300k Ω) plus 180 Ω R₅₀₆. If C₅₀₄ must be replaced, select a new one with care—the original is a tantalum type. Any drift caused by heat will make the vertical roll. The narrow positive-going inverted and amplified vertical-sync pulses of terminal 31 lock the vertical oscillator to the sync pulses (when R₅₀₅ hold control is correctly adjusted) with oscillator sawteeth appearing at terminal 30.

Positive feedback to produce oscilla-

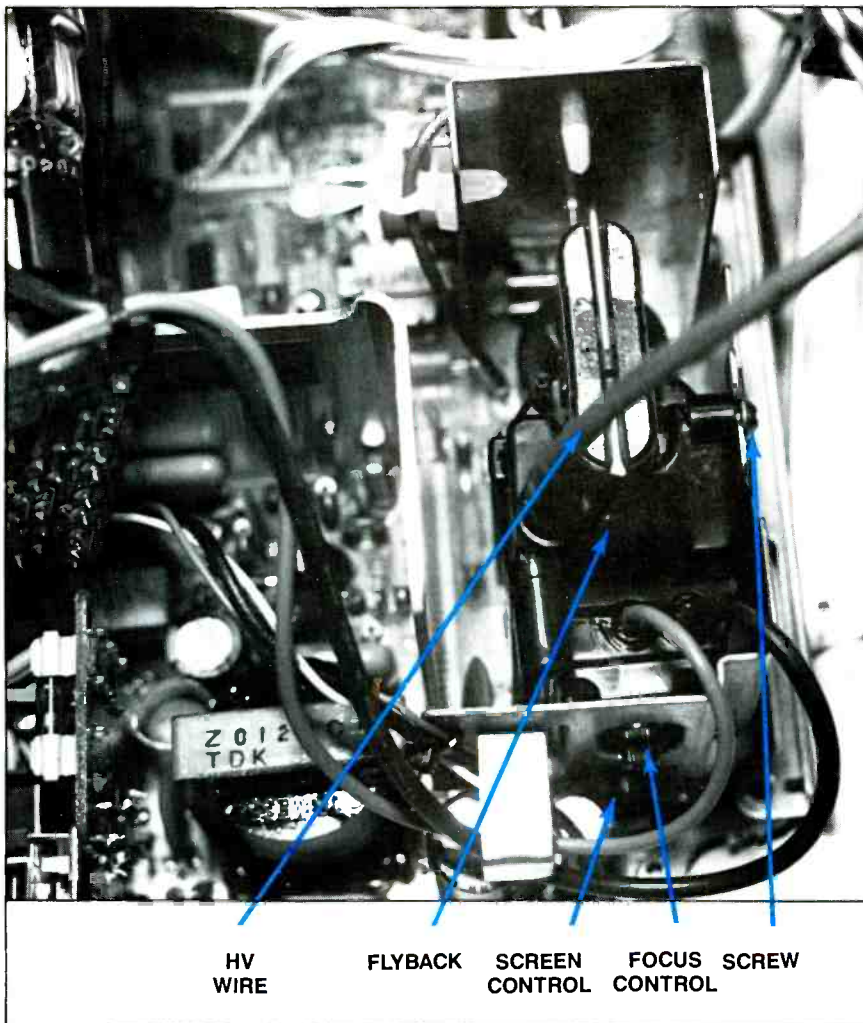

Arrows show the locations of several important components in the model 9H102 receiver with an H5 chassis. To remove a defective horizontal-output transformer (flyback), remove several screws from the side panel, then desolder the transformer connections at the circuit board.

- R_{507} (the $2k\Omega$ vertical-size control might be open or erratic).
- R_{508} (a $3,300\Omega$ resistor connecting to the size control might have changed value).
- R_{519} (the 5.6Ω $\frac{1}{2}W$ resistor between the Q_{501} emitter and the Q_{502} collector).
- C_{509} (a $1\mu F$ capacitor for negative-feedback from the cold end of the yoke).
- Q_{501} and Q_{502} (the vertical-output transistors—check them every time).

If the screen shows a single white horizontal line in the center, check Q_{501} and Q_{502} , test for an open R_{521} (a 33Ω resistor in the $+28.5V$ supply), test R_{518} (a $3,900\Omega$ resistor for yoke-current balancing), and check the DY_{601} deflection yoke. Replace all of the components that tests show are defective. High leakage or shorts in both output transistors often overload 5.6Ω R_{519} , badly burning or opening it. Check R_{519} in-circuit each time the output transistors are replaced. If one of the vertical-output transistors is defective, leaky or open, replace both transistors at the same time.

Sound distortion

Before the sound signal in the Sharp 9H100 is separated from the composite video, 24-pin IC201 has performed several picture and video functions such as supplying picture-IF amplification, picture detection, AFT and AGC for IF

and tuner. Next are the sound (audio) functions, including sound-IF amplification, sound detection, an active audio attenuator and one audio pre-amplifier that produces an audio output at terminal 3. Notice that the $+12V$ supply connects to terminal 20 with ground at terminal 12. Terminal 1 connects on the inside of IC201 to the electronic audio variable-attenuator. Terminal 1, however, connects on the outside of IC201 to a $50k\Omega$ variable control on the front panel, where the viewer can adjust the sound volume.

The sound output at IC201 terminal 3 is sent to Q_{303} sound driver, a small transistor. Q_{303} then drives Q_{301} (an NPN-type power transistor) and Q_{302} (a PNP-type power transistor) with the two power-transistor bases paralleled and the two emitters paralleled. Q_{303} driver's collector is connected directly to the paralleled Q_{302} and Q_{301} bases. When the driver collector becomes more positive, the NPN Q_{301} draws increased C/E current, but the PNP Q_{302} passes decreased C/E current. Therefore, only one of the sound-output transistors draws current at a time, producing push-pull class B output. The signal for T_{301} , the sound-output transformer, comes through C_{302} , a $2.2\mu F$ capacitor from the paralleled emitters of Q_{301} and Q_{302} . R_{301} powers the built-in speaker or external headphones.

Those components comprise the entire sound system circuitry except for the important B+ source. $+125V$ passes through $2,700\Omega$ R_{301} , which reduces it to $+114V$, connected to one end of the T_{301} primary and the collector of Q_{301} .

During audio troubleshooting, you can locate the sources of most weak or distorted sound problems by performing accurate dc-voltage measurements, dependable transistor tests and audible tracing that uses an external audio amplifier and speaker. In this repair of another model 9H100, I found only $+67.2V$ at the collector ($+114V$ is normal) and $+64.1V$ at the emitter of Q_{301} . R_{301} ($2,700\Omega$ 2W) was dissipating excessive power and therefore producing too much heat. (See Figure 2.) Remember, there are no components between $+125V$ and the Q_{301} collector except R_{301} . Therefore, the low voltage at Q_{301} 's collector and the hot resistor indicate excessive current.

An in-circuit transistor test of Q_{301} and Q_{302} indicated both were leaky. After I removed them from the circuit and checked them out-of-circuit, Q_{301} tested leaky but Q_{302} checked normal. Both were replaced. Q_{303} was tested in-circuit and found to be normal.

When the receiver was switched ON, the sound was better but music was distorted at louder volume. At first I suspected the speaker, but the distortion

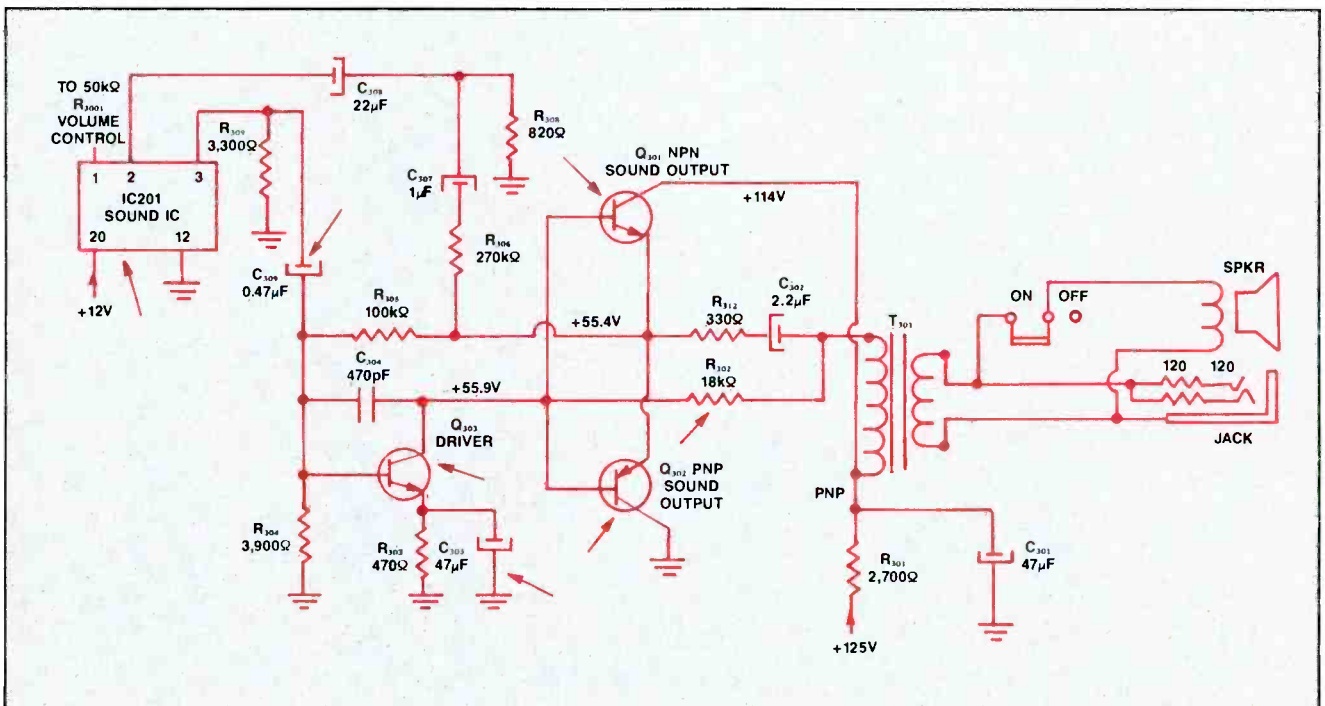

Figure 2. Try the easy things first is good troubleshooting advice for a 9H100 audio circuit without sound or with low-volume sound: measure the dc voltage at Q_{301} 's collector, expecting a normal $+114V$. Low voltage there must be investigated and the cause repaired. Past experience shows that distorted sound often is caused by a defective Q_{301} , Q_{302} , R_{302} or IC201.

was more noticeable when earphones were plugged in and listened to intently. By signal-tracing with an external audio amplifier and speaker, I proved that the audio quality was normal at IC201 pin 3. A number of voltage and resistance readings of the audio-output circuits revealed that $18k\Omega$ R_{302} had increased to about $58k\Omega$. Replacement of the resistor (plus the two transistors formerly replaced) brought normal sound.

Capacitors have been troublemakers in the 9H100. For example, C_{309} ($0.49\mu F$) coupling capacitor and C_{303} ($47\mu F$) emitter bypass capacitor always should be tested when the complaint is weak sound.

Loss of video

IC801, which has 42 terminals, performs functions for the video, sync, chroma, vertical and horizontal oscillators and the x-ray-protection circuits. Consequently, defects inside IC801 can produce a bewildering list of possible symptoms. For example, IC801 defects can cause a black screen, incorrect video, loss of color, insufficient ver-

tical height, a very dim picture and many more symptoms.

An adjustable dc voltage from the picture (or contrast) control connects to IC801 terminal 5, so the customer can vary the contrast. The output of the brightness control connects to 41. An increase of the terminal 41 voltage (through the IC801 internal circuitry) reduces the dc voltage at terminal 22. Terminal 22 drives emitter follower Q_{403} , which in turn drives all emitters of the three color-output transistors to less positive, producing a brighter picture.

Adjustable positive voltage from the tint control connects to terminal 8, and terminal 1 receives the variable dc voltage from the color control. Signals from various taps of the 3.58MHz oscillator can be scoped at terminals 16, 17 and 18. Outputs for the bases of the three color-amplifier transistors are at terminals 19, 20 and 21. Supply voltage of +12V enters at terminal 3, and terminal 32 is grounded. As stated before, the vertical waveform exits at terminal 26, and the horizontal waveform exits at terminal 24.

Because many separate functions are performed by IC801, a large number of failures can be predicted. Servicing over a longer period of time has shown this to be true. Several IC801s have been replaced in my shop because of video or color problems.

IC801 has the same part number and uses the same replacement in both the H4 chassis 9H100 and in the H5 chassis 9H102, although the video and chroma circuitry around IC801 is not identical for the two models. IC801 is located under the bell of the picture tube—a very inconvenient place to work. Sometimes the CRT must be moved temporarily, as described previously. Order IC801 from the manufacturer or an authorized service depot.

Interrupted video

Color on a dim raster without black-and-white parts of the picture usually indicates a loss of -Y video. First, test by turning the brightness and contrast controls to maximum. If the video is missing while the color control is turned to maximum, a negative-looking picture will appear. But before you begin a long

Come Out of the Dark.

Highlight this opportunity to enrich your skills at the 1989 National Professional Electronics Convention, August 7-12, Tucson, AZ. Programs will include:

- Technical Training and Certification
- Management Seminars & Trade Show
- \$60 Registration Discount thru Jan. 30.

For a registration form and more information, rush the following to NESDA:

Name _____

Address _____

City _____ State _____

Zip _____

Phone _____

National Electronics Sales &
NESDA
Service Dealers Association

2708 W. Berry St.
Ft. Worth TX 76109
(817) 921-9061

*One of a series.

Call Us For...

FRIENDLY SERVICE

QUALITY PARTS

For everything you need in the way of dependable electronic parts and components, look to the all-new, expanded MCM Electronics Catalog. We offer a huge selection of nearly 11,000 items (more than 500 of them brand-new). And most items are in-stock, ready for shipment in 24 hours. Order your FREE copy today and discover why MCM is your best choice!

For your FREE copy, call TOLL-FREE
1-800-543-4330

MCM ELECTRONICS
858 E. CONGRESS PARK DR.
CENTERVILLE, OH 45459-4072
A PREMIER Company

Source No. ES-41

Circle (13) on Reply Card

search through the complex video circuitry, check something simple that has caused trouble in many 9H100 and 9H102 models.

When switch SW₈₅₁ is open, it disconnects the color-output emitters from the video driver, thus removing the video from the picture and reducing the brightness. Also, the low brightness that remains cannot be varied by the brightness control. (The switch apparently is added to make faster and more accurate screen-color adjustments during the set-up procedure.)

Switch SW₈₅₁ is mounted on the CRT-socket board B (on the wiring side, it is in the lower-right corner). This is a 2-position switch, with the knob on the components side sliding up or down, but it easily might be bumped and changed

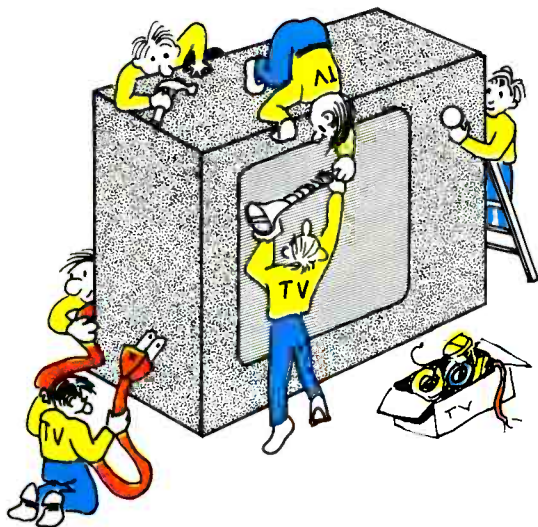

to the OFF position when a technician is working on something else in the area.

Slide the switch to the ON position and notice if the video returns. Moving the switch might be the only repair necessary to bring back the video. However, these switches can develop corroded contacts that cause intermittent operation or no video. If the problem is erratic contacts, use some kind of non-corrosive cleaner on them. A short puff of canned tuner-cleaner spray might meet with some success, but do not use too much, and wipe away all surplus cleaner so it does not drip.

Another potential trap for the unwary in model 9H102 includes video and audio inputs (from an external VCR) and another sliding switch for selecting TV or VTR. If this SW₅₀₀₁ switch is accidentally moved to the VTR position, there might be no picture or sound, only a dim raster. First, test the operation of

SW₅₀₀₁ switch. This switch, the video input, the audio input and the UHF/VHF antenna connectors are located on the PSB-I board where they are accessible.

A majority of the receiver's circuits are operated normally during the playing of a VCR tape, after the video and audio inputs are connected and the switch moved to the VTR position. (Note: VTR is the Sharp acronym for videotape recorder, but VCR is the usual American acronym for videocassette recorder. Therefore, VTR and VCR have the same meaning.)

Switching between TV and VTR functions is performed by two integrated circuits. IC302 electronically switches the audio signals. IC401 electronically switches the video signals. The circuitry is somewhat complex, involving pre-amplifiers for audio and video. My recommendation is that you don't perform a lot of testing of the switching circuit without the correct schematic.

Anyway, the point for all of us to be careful about is the position of the SW₅₀₀₁ sliding switch that selects VCR video and audio inputs. If you want TV operation, make certain the switch is in the TV position.

Adjusting the sub-brightness

During troubleshooting, the sub-brightness control often is rotated in an attempt to produce sufficient brightness for a raster or to make the raster bright enough for evaluation. Other controls also might have been turned during various preliminary tests. Of course, these controls require accurate readjustment after all repairs are made. The sub-brightness control needs careful adjustment because it is not a customer-accessible control. Separate instructions are provided here for the two Sharp models.

For 9H100 receivers, tune in a normal color program and adjust the picture (contrast) control maximum clockwise. Adjust the brightness control to its center of rotation. Now turn the sub-brightness control (R₄₃₁) as required to provide normal brightness of the picture.

For 9H102 receivers, the method is only slightly more complicated. Tune in a normal color program. Rotate the picture control to maximum clockwise position and turn the brightness control to the midpoint of its rotation. With short clip leads, connect the positive terminal of a 47 μ F capacitor to TP404

(video at the base of Q₄₀₆) and the negative terminal to ground at TP405. This eliminates the video. Adjust the sub-brightness control until a dim white raster is obtained. Remove the capacitor and the clip leads and test for normal brightness using the viewer-operated brightness control.

Servicing techniques for small-screen color TV portables should be similar to the methods used on larger-screen or console models. However, some shifts of mental attitude are required. Increased finger dexterity and less brute strength are needed. Many components are much smaller and placed nearer to each other. At times, a large component or circuit board must be moved temporarily. In these Sharp portables, for example, you can save time by sliding the CRT forward when replacing IC801 or the components around it.

One last tip: Do not forget to pull out the ac power plug from the interlocked socket when changing from 120Vac to +12Vdc operation with the 9H102. At the other extreme, remember to pull out the interlocking 12V plug when battery power is not in use and 120Vac operation is desired. Sometimes a simple mistake of this nature can cause a technician more time and trouble than many serious defects.

Always use an isolation 120Vac transformer for powering a color receiver. This provides acV safety for all ac-operated test equipment, the TV receiver and you, the technician.

If your isolation transformer is part of a variable-output ac transformer, you have the best possible combination. Variable line voltage from zero to 130Vac has many valuable uses, particularly when you are troubleshooting shut-down circuits and low-voltage power supplies.

Circuits in these small color TV receivers probably are as complicated as those in many full-sized color models. Of course, the smaller receivers are more difficult to trace visually, electronically and physically. Therefore, schematics with detailed information (such as Photofacts) are more essential for the tiny models than the full-sized models. If you have access to service information and replacement components, accept these small color receivers for repairs without hesitation. Except for the crowded area inside the TV, testing and replacing defective parts are almost identical to the same activities in large-screen color receivers.

ES&T

Products

Service diagnostics kit

The SuperSoft service diagnostics kits, available from *Jensen Tools*, is a diskette-based, full-system diagnostic software that runs on IBM/PCs, IBM/PC-XTs and IBM/PC-ATs or compatibles. The program locates and reports on all peripherals in the system. The kit also includes two ROM POST modules, which allow the user to test systems that won't boot; wrap-around plugs for the parallel and serial ports; and two digital test diskettes for floppy drive testing.

Circle (75) on Reply Card

Oscilloscopes

The 2400B Series from *Tektronix* features automatic, push-button measurement and 400MHz bandwidth. Options include a GPIB interface, built-in counter/timer/trigger with word recognizer, a DMM and a video waveform measurement system. The 2467B has 4cm/ns visual writing speed and, combined with the DCS01 digitizing camera sys-

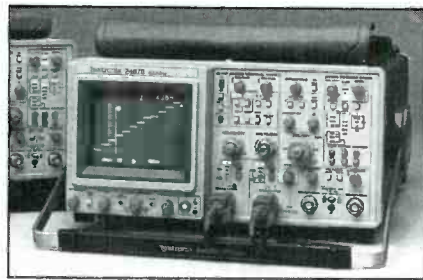

tem, becomes a real-time waveform digitizer able to capture single-shot events up to 400MHz.

Circle (76) on Reply Card

Oscilloscope calibrator

B&K-Precision's model 1400 oscilloscope calibrator generates voltage and time calibration signals as well as an uncalibrated sine-wave output signal. The voltage range is from 1mV to 100V peak square waves in a 1-2-5 sequence. Accuracy into a standard 1MΩ oscilloscope input is 0.5%. The time output is also controlled in a 1-2-5 sequence, ranging from 0.5 seconds to 10ns, with 0.015%

accuracy. Rise time is less than 1ns, and the sine-wave output is fixed at 1kHz.

Circle (77) on Reply Card

Portable oscilloscope

The model 1010 from *HMC* is a portable oscilloscope that offers internal and external triggering, dc to 10MHz bandwidth, 12 sensitivity ranges and 21 time-base ranges. Vertical sensitivity can be selected from 10mV/div to 50V/div, and time base can be varied from 0.1μs/div to 0.5s/div. Coupling modes include ac, dc, TV frame and TV line.

Circle (78) on Reply Card

Angled desoldering tips

PACE has introduced a new range of angled desoldering tips that make surface-mount pads and conductors more visible during desoldering. The tips can be used with any *PACE* solder extractor and desoldering systems. Solder clogging does not occur in the tips because the angle is very close to

Continued on page 48.

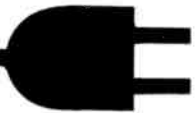

Plug in!

To the NESDA system.

YOUR BUSINESS is in the world's fastest changing industry. If you're not careful, you could find your business in the dark.

But, you don't have to stay there.

Through a system of local, state, and regional groups, the **National Electronics Sales & Service Dealers Assn. (NESDA)** keeps members up-to-date with the fast pace of advancing technology while offering:

- ◆ Managerial and technical training.
- ◆ Business contacts.
- ◆ Technical and management certification.
- ◆ Information on new products.
- ◆ Legislative activities that affect the industry.

Don't be left in the dark. Let the NESDA system work FOR YOU!

For more information and an application, write to:
NESDA, 2708 W. Berry St., Ft. Worth, TX 76109; Ph (817) 921-9061

Name _____

Bus. Name _____

Address _____

State _____ Zip _____ Phone _____

Member of State Local Assn. _____

HANDS-ON PC REPAIR TRAINING

NAC offers the highest quality advanced training available for PC technicians. The course and its documentation focus on the IBM personal computer lines, from PC to PS/2, peripheral devices, and compatibles such as Compaq and AT&T. Network maintenance training is also available.

- Diagnose more quickly and accurately, complete repairs faster, and reduce costs.
- Discover better diagnostics, parts sources, and new trouble-shooting tools and test units.
- Toll-free technical help and parts-locator line, free technical and vendor update service.
- Used by GTE, ITT, Rockwell, Xerox, SoCal Edison, regional Bell companies, the U.S. Dept. of Commerce, and many others.

Our five-day PC Maintenance Course is offered in California, New York, Washington, Atlanta, Chicago, St. Louis, Dallas, Seattle, and other major cities. Call without obligation to get a course outline and dates for the class locations most convenient to you.



National Advancement Corporation

Computer Hardware Training Specialists

2730-J South Harbor
Santa Ana, CA 92704
(714) 754-7110

Circle (14) on Reply Card

Continued from page 47.

the heater assembly, keeping the tips far above solder melt temperature.

Circle (79) on Reply Card

Digital tester interface pod

The 9100A digital test system from *John Fluke Mfg.* now supports advanced 32-bit designs with the 9132A memory interface pod, which will enable the test system to test 80386 and 68020 microprocessor-based boards. The in-



terface pod incorporates the HyperTEST RAM test algorithm, which can test 1Mbyte of the unit under test's RAM in one second. In addition to ROM and RAM tests, the 9132A processor support package includes a microfloppy of 9100A programs providing the capability for isolating bus faults, and a sync module adapter helps speed up the fault-finding process.

Circle (80) on Reply Card

Hand-held DMM

The model 2200, *Triplett's* hand-held digital multimeter, features a 3½-digit LCD readout and overload protection of up to 450V on all ohmmeter circuitry. The multimeter provides 200mVdc to 1,000Vdc in five ranges; 200Vac to 750Vac in two ranges; 200mAdc to 2Adc in five ranges; 200Ω to 2MΩ in five ranges; diode test and FE measurements.

Circle (79) on Reply Card

Soldering stations

Contact East has introduced the models EC1000ESD and EC2000ESD soldering stations, which are ESD-safe and temperature-controlled. The systems use thyristor power control with 0.0V thyristor drive. The tip temperature is controlled to within ±10°F through the range 350° to 850°F.

Circle (80) on Reply Card

Computer-controlled DMMs

Two computer-controlled, hand-held

DMMs have been introduced by *Chenesko Products*. The SK-6130 and SK-6135 feature a sampling rate of 20 times per second for min/max capturing of 50mS transients; a BCD data output; data hold; continuity and diode tests; auto/manual ranging; and 0.1% basic dcV accuracy. The model SK-6135 features true rms measurements.

Circle (81) on Reply Card

Service tool set

A 20-piece precision tool set, the model K-600 from *Jonard Industries*, includes three pliers, two screw drivers, a magnifier, a soldering iron, two tweezers, a solder aid, an alignment tool, needle files, a burnisher, a pin vise, a solder core, two nut drivers and miniature screw drivers.

Circle (82) on Reply Card

Floppy drive repair tool

AVA Instrumentation has introduced a floppy drive repair tool, the MacIntosh adapter card (p/n 10371). This adapter

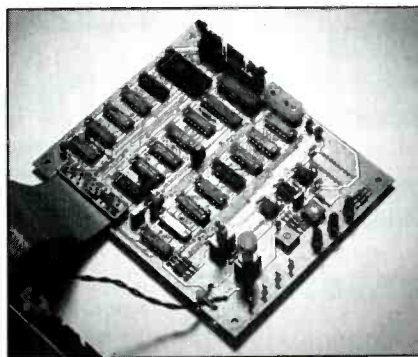

card allows testing and alignment of the MacIntosh 400K and 800K drives with any AVA floppy drive tester products.

Circle (83) on Reply Card

Buyer's guide

Design Solutions' Electronic CAD *Buyer's Guide* for personal computers features more than 150 items, including worksheets for vendor comparison. The guide was designed for both first-time buyers and experienced workstation CAD users.

Circle (84) on Reply Card

Hardware console

The BOA, from *Global Specialties*, transforms IBM/PCs and compatibles into microcomputer applications workstations while allowing all normal applications to continue. The hardware

console includes D/A and A/D converters, a digitally programmable gain circuit, built-in sine/TTL output function generator, microphone and audio amplifiers, a solderless breadboarding socket area, a switch-selectable I/O decoder and more.

Circle (85) on Reply Card

Surge suppressor

The model PTD 209 Fax-Line surge suppressor from *Perma Power Electronics* protects facsimile equipment and computers with modems against surges on power lines and telephone lines. The unit employs a 3-element gas tube and three MOVs to reduce the levels of transient surge energy to a safe level. Automatic shut-down disconnects the equipment if the power-line surge suppressor element wears or burns out.

Circle (86) on Reply Card

Coaxial cable kit

L-COM has introduced a kit that includes an assortment of cable types to solve interfacing problems. Each cable is made up of a 3-foot length of RG58A coax with 50Ω impedance. The eight cables included mate with other SMA, BNC, TNC and N-type receptacles. The SMA connectors have a gold-plated body and center pins with Teflon insulators.

Circle (87) on Reply Card

Multimeters

Beckman Industrial has introduced the models HD151, HD152, and HD153 3½-digit, heavy duty, auto-ranging

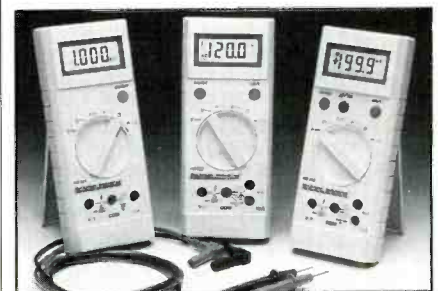

digital multimeters, which offer hands-free operation and audible signaling. The DMMs feature dc voltage ranges of 200mV, 2V, 20V, 200V and 1,500V with a resolution of 100μV. The HD150 has ac voltage ranges of 200mV, 2V, 20V, 200V and 1,000V with a resolution of 100μV. Current ranges (ac and dc) for the HD153 and HD152 are 20mA,

200mA and 10A. The HD151 current ranges are 20mA and 200mA. All three have 10 μ A resolution.

Circle (88) on Reply Card

Power-line interrupter

Electronic Specialists has introduced the model PI-15-O/U (over- and under-voltage) and PI-15-U (under-voltage only) Power Line Interrupters, which disconnect power from controlled apparatus when ac line voltage is disrupted or exceeds user-selectable limits. The interrupters, which can accommodate a 15A resistive load or a 10A inductive load, feature voltage-interrupt level selection, power reset, integral spike/surge suppression, and response delay to prevent false interrupts.

Circle (89) on Reply Card

Battery tester

The Universal battery tester from *Performance Electronic Products* allows users to determine the condition of deep-cycle, high-capacity storage batteries. The hand-held tester shows the internal impedance of a battery subjected to a 96A electronic load for ten seconds, and indicates if the tester is connected to an excessive voltage or if the leads are reversed.

Circle (90) on Reply Card

Computer service kits

Davle Tech has introduced models CKS-8 and CKS-16 computer service kits. The CKS-8 basic kit includes a chip inserter and extractor, a 3-claw holder, tweezers, four screwdrivers, two nutdrivers and a torque screwdriver. The CKS-16 includes additional soldering tools.

Circle (91) on Reply Card

Test probe kits

The ETK520 series SMD circuit-test probe kits from *OK Industries* are designed for probing SMD and densely packed circuits. The series features a test probe with a tip that is extendible to 2 inches. The L and X models in the series have gold-plated banana connectors. All models are rated for 1,000V and 5A maximum.

Circle (92) on Reply Card

Spike-sag-surge recorder

Amprobe Instrument's model LAS-800, a spike-sag-surge recorder,



monitors and records voltage dips, voltage increases, and high-frequency impulses. Ranges are 0V-220V/440V/880V, full scale, 50Hz or 60Hz. Nominal voltage ranges are average responding, calibrated in terms of rms. Voltage ranges are peak-sensing, but scaled in terms of rms.

Circle (103) on Reply Card

Field service software

MAGIC Solutions' ServiceMagic version 1.4 field service management software, written in C and Btrieve, is a fully integrated, menu-driven microcomputer program that tracks service personnel schedules, on-site service, depot repair and hot-line telephone support. The software maintains service contracts and customer histories, creates work orders and return authorizations, and manages shipping and inventory.

Circle (94) on Reply Card

Inventory control system

The P-Tracer from *Management Technix* is a computerized parts inventory-control system that offers a tiered-menu user interface, search/display algorithms that locate parts/requisition data, and bar-code label generation. The software is designed for use on IBM-compatible PCs.

Circle (95) on Reply Card

Acoustics meter

The Subliminal Annoyance Meter (SAM) from *Electron Processing* detects and measures acoustic waves in the frequency range of 10kHz to 40kHz. The meter includes a receiving probe attached via a 5-inch cable.

Circle (96) on Reply Card 

ATTENTION VCR TECHNICIANS



VCR REPAIR PARTS KIT

Now you can do most of your VCR repair jobs the **same day**. Parts Express VCR Parts Kit makes this possible. It contains over 45 of the most commonly used parts to repair RCA, Hitachi, Fisher, Sanyo, Lloyds, Panasonic, Sony, Sharp, JVC, Samsung, TMK, GE, Magnavox, and more. Idler assemblies, pinch roller, sensing transistors, switches, and lamps are included in this comprehensive kit. You also save over \$20.00.

Kit contains replacements for: Sharp (2) NIDL0005, (2) NIDL0006, (1) NPLY-V0051, Panasonic (2) VXP0329, (2) VXP0401, (2) VXP0344, (2) VXP0521, RCA (1) 150614, (1) 164113, (1) 150650, Hitachi (1) 641311, Fisher/Sanyo (1) 143-0-4204-00300, (2) 143-0-4804-00100, (1) 143-0-4904-00900, (1) 143-0-7417-20002, RCA/Hitachi (2) up/down switch, (5) 161757 sensing transistors, Panasonic lamps (2) XAMQ27P150W, (5) XAMV0019, (5) XAMV725, (1) Molybdenum grease. Normal dealer cost of over \$110.00. (All parts are available individually for reorders.)

Order #
400-950

\$89⁹⁵
Plus shipping



VCR IDLER TIRE KIT

This popular kit contains 150 of the most popular idler tires (10 each of 15 different sizes). With this kit in your stock room, you can do over 90% of VCR repair jobs the same day, saving time and money! Also included is our comprehensive cross reference listing over 80 manufacturers' assembly numbers and over 200 model numbers. A \$400.00 retail value. (All tires are available individually for reorders.)

Order #
400-900

\$55⁰⁰
Plus shipping

**FREE
CATALOG**



**Parts
Express**
International, Inc.

CALL TOLL FREE
1-800-338-0531

340 E. First St., Dayton OH 45402
Local—1-513-222-0173

Circle (15) on Reply Card

Index of 1988 articles

Compiled by Pamela S. Fleener

Articles are listed by alphabetically arranged subjects. For the month and page number of the article, look to the right of each column.

■ ARTICLES

ANTENNA SYSTEMS

- Choosing the right satellite antenna system, by James Kluge Aug...10
What are earth are kelvins?, by James E. Kluge Jul...22

AUDIO SERVICING

- That dreaded drift, by Joseph J. Carr, CET Mar...78

AUTOMOBILE ELECTRONICS

- Electronics and automobiles: A revolution in the making, by Mike Ergo Sep...26

BATTERIES

- Battery problems in electronic equipment, by Joseph J. Carr, CET May...10

CIRCUITS/COMPONENTS

- Creating resistor values, by Art H. Meyerson Mar...58
Troubleshooting the op-amp, by Christopher H. Fenton Mar...62
Circuit analysis and troubleshooting quiz—Part II, by Bert Huneault, CET May...42
A build-it-yourself signal injector, by Gregory Lettera Jun...52
Simplifying electronic circuit schematics, by Robert G. Mousseau Jul...8
Unusual uses for varactor diodes, by Joseph J. Carr, CET Aug...46

COMPUTER SERVICING

- Special report introduction, Computer Servicing, by Conrad Persson Jan...15
Servicing the Apple II+ computer, by Michael J. Zoiss Jan...24
Servicing the Commodore 1541 disk drive, by Andy Balogh Jan...49
Servicing the Commodore 1541 disk drive, Part II, by Andy Balogh Feb...26
Preventive maintenance: Cleaning supplies for computer maintenance, by Gil O'Brien Oct...46
Computer servicing: Troubleshooting cable related problems Nov...10

EQUIPMENT

- Break-out boxes: Active vs. passive, by Manfred R. Will

- and Cindi L. Kemper Jan...52
Logic probes: Troubleshooting to the component level, by Conrad Persson Jan...54
An oscilloscope update, by Conrad Persson Apr...22
The digital oscilloscope: Providing the competitive edge, by Brad Harris Jun...20
Using the logic analyzer, by David J. Blakemore Jun...16
The new breed of multimeters, by Conrad Persson Sep...14
Build your own microwave oven test bottle, by Donald P. Hopkins Oct...53
A homemade high-vacuum desoldering system, by William L. Call Nov...22
Choosing a hand-held test instrument, by George Gore Dec...8

EQUIPMENT MODIFICATION

- Extending DVM ohmmeter ranges, by Art H. Meyerson Mar...60
Repair that digital DMM, by Victor Meeldijk Jun...42

LOCATING REPLACEMENT PARTS

- The case of the missing diode, by Conrad Persson .. Dec...22

MANUFACTURERS

- Buyer's Guide 88, by the ES&T staff Mar...8

MICROPROCESSORS

- Troubleshooting microprocessor circuits—Part I, by Tom Allen Jan...16
Troubleshooting microprocessor circuits—Part II, by Tom Allen Feb...42
Isolating microprocessor-related problems, by Gregory d. Carey, CET Jun...8

POWER CONDITIONING

- Power conditioning: Protecting your electronics investment Nov...18

SOLDERING

- Hand soldering surface-mount components, by Christopher H. Fenton May...18

STATIC

- The basics of static control, by Mike Voss Jul...44
Locating ESD hazards, by Dan C. Anderson Oct...42

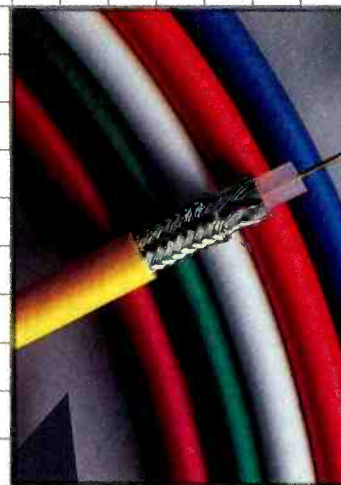

TRAINING AND LITERATURE

Continuing your electronics education, by Conrad Persson Aug...42

TV SERVICING

Servicing voltage regulators, by Greg Carey, CET... Jan...8
 Critical sound problems, by Homer Davidson..... Feb...48
 Servicing J.C. Penney vertical problems, by Homer L. Davidson..... Mar...68
 TV servicing and the composite video waveform, by Conrad Persson..... Apr...10
 Quick tests for B&W TVs, by Homer Davidson.... May...22
 Solving the TV shutdown puzzle, by Bert Huneault Aug...18
 Unusual lines in the picture, by Homer L. Davidson, CET Sep...49
 Troubleshooting low-voltage IC regulators, by Homer L. Davidson..... Nov...46
 Servicing Sharp's small color TVs-Part I, by Homer L. Davidson..... Dec...14

VCR SERVICING

Special report introduction, VCR servicing, by Conrad Persson Feb...13
 Isolating head-related failures, by Gregory D. Carey, CET Feb...14
 A VCR repair case history, by Victor Meeldijk..... Feb...20
 A VCR repair case history—the sequel, by Victor Meeldijk Oct...10
 Servicing VCR servo systems, by Stephen J. Miller Oct...18

DEPARTMENTS

BOOK REVIEWS

Advanced Digital Troubleshooting, by Alvin J. Evans Jul...20
 Alarms: 55 Electronic Projects and Circuits, by Charles D. Rakes Sep...25
 Application Notes Digest; D.A.T.A. Business Publishing, 33rd edition..... Nov...53
 Amplifiers Simplified, with 40 Projects, by Delton T. Horn May...59
 Basic Electronics Course, 2nd ed., by Norman H. Crowhurst..... Apr...46

The Benchtop Electronics Reference Manual, by Victor F.C. Veley May...58
 Beyond the Transistor: 133 Electronics Projects, by Rufus P. Turner & Brinton L. Rutherford..... May...59
 Bob Middleton's Handbook of Electronic Time savers and Shortcuts, by R.G. Middleton..... Sep...25
 Cable Television Technology, by Kenneth T. Deschler Sep...21
 CET Exam Book, by Ron Crow & Dick Glass Feb...8
 The CET Study Guide, 2nd ed., by Sam Wilson... Apr...46
 Commodore 128 Troubleshooting & Repair, by John Heilborn Apr...46
 Compact Disc Troubleshooting & Repair Guide, by Neil R. Heller and Thomas Bentz Feb...8
 Complete Guide to VHS Camcorder Troubleshooting and Repair, by John D. Lenk Sep...21
 Crash Course in Electronics Technology, by Louis E. Frenzel, Jr. Jun...26
 Digital Electronics Troubleshooting, 2nd ed., by Joseph J. Carr May...58
 Digital IC Digest; D.A.T.A. Sep...25
 Digital IC Handbook, by Michael S. Morley Oct...52
 Electronic Conversions, Symbols and Formulas, 2nd ed., by Rufus P. Turner & Stan Gibilisco May...58
 Electronic Databook, 4th ed., by Rudolf F. Graf... Jul...20
 Electronic Display Devices, by Richard A. Perez... May...58
 Electronic Servicing Data and Procedures, by Robert C. Genn, Jr. Sep...21
 Enhanced Sound—22 Electronics Projects for the Audiophile, by Richard Kaufman Oct...52
 500 Electronic IC Circuits with Practical Applications, by James A. Whitson..... Apr...46
 44 Power Supplies for Your Electronic Projects, By Robert J. Traister & Jonathan L. Mayo May...59
 Fundamentals of Automotive Electronics, by V.A.W. Hillier Apr...46
 Handbook of Polyphase Electric Motors, by John E. Traister Oct...52
 Handbook of Radio Communications Servicing & Maintenance, by Harry L. Helms..... Dec...59
 Handbook of Standardized Terminology for the Power Sources Industry..... Jul...20
 Handbook of Video Camera Servicing and Troubleshooting Techniques, by Frank Heverly Aug...27
 How to Become a Successful Consultant in Electronic Servicing, ATC Books..... Feb...8

How to Design Solid-State Circuits, 2nd ed., by Man- nie Horowitz and Delton T. Horn.....	Jul...21
How to Read Electronic Circuit Diagrams, 2nd ed., by Robert M. Brown, Paul Lawrence and James A. Whitson.....	Apr...46
How to Test Almost Everything Electronic, 2nd ed., by Jack Darr and Delton T. Horn.....	May...58
IC User's Casebook, by Joseph J. Carr.....	May...58
IBM PC Advanced Troubleshooting & Repair, by Robert Brenner.....	May...58
IBM PC Peripheral Troubleshooting & Repair Guide, by Charles J. Brooks.....	Feb...8
The Illustrated Dictionary of Electronics, 4th ed., by Rufus P. Turner & Stan Gibilisco.....	Jul...20
The Illustrated Home Electronics Fix-It Book, 2nd ed., by Homer L. Davidson.....	May...59
Interface ICs Digest, Ed.24, D.A.T.A.....	Sep...25
Learning Electronics: Theory and Experiments, with Computer-aided Instruction for the Commodore 64/128, by R. Jesse Phagan and William Spaulding.....	Jul...20
Master Guide to Electronics Circuits, by Harry L. Helms.....	Oct...52
Master Handbook of 1,001 Practical Electronic Circuits—Solid-state ed., edited by Kendall Webster Sessions.....	Sep...21
Meters and Scopes: How to Use Test Equipment, By Robert J. Traister.....	May...59
Microcomputer Hardware, Operation and Trouble shooting with IBM PC Applications, by Byron W. Putnam.....	Feb...8
New Handbook of Electronic Data, by Martin Clifford.....	Oct...52
1988-89 Technical Guide and Cross Reference Manual, NTE Electronics.....	May...58
Printer Troubleshooting & Repair, by John Heilborn.....	Jul...20
Radio Manufacturers of the 1920's, by Alan Douglas.....	May...58
Rework and Repair for Electronics.....	Jul...20
Solid State Electronics Theory with Experiments, by M.J. Sanfilippo.....	Feb...8
Troubleshooting & Repairing Your Commodore 64, by Art Margolis.....	Jul...20
Troubleshooting with the Oscilloscope, 5th ed., by Robert Middleton, revised by Joseph J. Carr.....	May...58
Turbo C Programming for the IBM, by Robert Lafore.....	Apr...46
Turbo Prolog Primer, revised ed., by Dan Shafer.....	Apr...46
20 Innovative Electronics Projects for Your Home, by Joseph O'Connell.....	Jul...20
Understanding and Repairing CB Radios, for the Pro- fessional Technician, by Lou Franklin.....	Dec...59
Understanding Automotive Electronics, 3rd ed., by William B. Ribbens.....	Jul...20
Understanding Data Communications, 2nd ed., by Gilbert Held.....	Jun...26
Understanding Satellite Television Reception, by S.E. Sutphin.....	Aug...27
Using the Triggered Sweep Oscilloscope, by Robert L. Goodman.....	May...58
VCR Model Cross-Reference and Parts Cross Reference; ISCET.....	Nov...53

PROFAX	Profax	month
---------------	---------------	--------------

GENERAL ELECTRIC	
IVCR2006W model, VCR.....	3027.....Jul

IVCR2018W model, VCR.....	3019.....Feb
NC-05X3/06X1 chassis, color TV.....	3032.....Sep
Projection TV 8-4500.....	3020.....Mar
PW chassis, model 40PW3000KA01 projection TV receiver.....	3037.....Dec

HITACHI	
CT1344 chassis, color TV.....	3029.....Aug
CT1358 chassis, color TV.....	3018.....Jan
CT2647/CT2648/CT2649 chassis, color TVs.....	3025.....Jun
CT2652, CT2653 color TVs.....	3024.....May
CT3020W/CT3020B.....	3033.....Oct
VHS VCR, model VT-63A.....	3035.....Nov

NAP	
E51-56 chassis, color TV.....	3030.....Aug
E54-10 chassis, projection TV.....	3021.....Apr
E54-15 chassis, projection TV.....	3026.....Jun
RD4502SL/RLC312SL color TV monitors.....	3036.....Nov

RCA	
PVM035 chassis, color TV.....	3031.....Sep
PVM050, color TV.....	3023.....May

ZENITH	
CM-139/B-0 (B) chassis, color TV.....	3028.....Jul
CM-139/B-3 (I) SD2511G/SD2581H.....	3034.....Oct
C2020H chassis, color TV.....	3022.....Apr
PV800 color monitor.....	3017.....Jan

SYMCURE	
RCA	
CTC39X chassis; frequent failure of 6ME6 horiz. ouput tube.....	Jul...19
CTC46H chassis; horizontal hold won't sync picture, HV won't adjust.....	Dec...26
CTC46H chassis; grainy picture and multiple ghosts after warm-up.....	Dec...26
CTC46H chassis; low brightness, no service line.....	Dec...26
CTC46H chassis; HV arcing, no raster.....	Dec...26
CTC46H chassis; retrace lines on screen.....	Dec...26
CTC46H chassis; low brightness, dim service line.....	Dec...26
CTC48 chassis; vertical might collapse when brightness is increased.....	Aug...26
CTC48 chassis; no control of brightness.....	Aug...26
CTC52, 52 and 53 chassis; vertical misconvergence of bottom half of picture.....	Aug...26
CTC53 chassis; no green in color.....	Aug...26
CTC58 chassis; edges of picture not straight.....	Jul...19
CTC58 chassis; vertical lines at edges are crooked.....	Mar...76
CTC58 chassis; poor gray tracking, green smear on right of video.....	Aug...26
CTC58 chassis; video smear to the right.....	Aug...26
CTC68 chassis; vertical at right side compressed.....	Mar...76
CTC71 chassis; varying color intensity.....	Jul...19
CTC71 chassis; picture too far to left, blanking bar at right.....	Jul...19
CTC72 chassis; intermittent or no raster, intermittent or no CRT heater voltage.....	Jul...19
CTC74 chassis; intermittent height, roll or loss of ver- tical sweep.....	Mar...76
CTC76 chassis; intermittent width change or loss of regulation.....	Jul...19
CTC81 chassis; no video, excessive brightness with retrace lines.....	Mar...76
CTC81 chassis; no vertical sweep.....	Mar...76
CTC81 chassis; not locked horizontally, has squeal and perhaps foldover with low HV.....	Mar...76

ZENITH

9HBIX chassis; loss of contrast and locking	Apr...18
13GC10 chassis; no vertical height	May...56
13HC10 chassis; no HV, RX234 open and Q204 shorted	Apr...18
16DB12X chassis; loses horiz. lock after warmup	Apr...18
17EC45, 19EC45 chassis; low brightness	May...56
17FC45, 19FC45 chassis; narrow picture with foldover	May...56
17FC45, 19FC45 chassis; out-of-sync color at edges, no color at center of screen	May...56
19ED45 chassis; intermitten horiz. foldover at right edge	Apr...18
19BC45 chassis with zoom; height excessive without zoom, normal with zoom	May...56
19GC45 and 19GC48 chassis; low brightness	May...56
23HC45 chassis; HV is zero, Q202 has no drive	Jun...58
23HC45 chassis; HV is zero, Q202 collector has 0Vdc	Jun...58
23HC45 chassis; insufficient height	Jun...58
23HC45 chassis; narrow picture, low HV	Jun...58
25FC45 chassis; no set-up horiz line; dim picture	Apr...18
25FC45 chassis; dim picture without color, video output bases had less than normal +voltage	Apr...18
SM1961W chassis; HV is excessive, QX3326's life too short	Jun...58
Z1310A chassis; intermittent high voltage or no HV	Jun...58

TECHNOLOGY

Audiotape gets rapid transit	Jun...28
Computer-aided design tool for microchips	Sep...24
Doubling the frame count	Aug...28
The 16Mbit DRAM	Oct...16
Sound and image—from one flat screen	May...8
Taking your VCR with you	Nov...28
Three dimensional camcorder	Feb...10
The ultimate in easy listening	Apr...8

TROUBLESHOOTING TIPS

ADMIRAL

9M45, vertical deflection reduced with red raster and retrace lines, no video	May...54
---	----------

CURTIS MATHES

AV725 VCR, dead tuner	Dec...48
-----------------------	----------

FISHER

FVH-805 VCR, no video, muted sound	Dec...48
------------------------------------	----------

GENERAL ELECTRIC

8-1304 (NF chassis), incomplete vertical deflection, unstable horiz. hold, low-volume audio	Sep...6
VCR model 9-7115, VCR stays in Pause/Still	Jun...54

MITSUBISHI

CS1952R, vertical foldover	Aug...16
----------------------------	----------

RCA

CTC 110, dark screen	Jun...54
CTC 120A, dead set, makes slight ticking sound	Jul...59

SEARS

528.4188005, no sound	Oct...49
-----------------------	----------

SHARP

19J65, dead set	Jul...58
-----------------	----------

SONY

KV-1513, sound almost inaudible	May...54
---------------------------------	----------

AUDIO CORNER

CD channel frames	May...60
The CD data structure	Mar...87
CD digital error correction	Apr...56
DAT: Where's it at?	Feb...64
Knowing your specs	Aug...60
More about decibels	Sep...70
More on audio servos	Jan...68
Servicing the compact disc player—Part I	Oct...60
Servicing the compact disc player—Part II	Nov...56
Servicing the compact disc player—Part III	Dec...60
Setting up a shop log—by computer	Jun...60
Some basics about frequency response	Jul...60

COMPUTER CORNER

Accessing read-only memory	Jan...70
Basic flip-flop design	Mar...84
Clean me!	Nov...64
Common hard-disk problems	Dec...62
House wiring provides the path	Feb...62
Interfacing computers to the analog world—Part I	Jun...62
Interfacing computers to the analog world—Part II	Jul...64
Interfacing computers to the analog world—Part III	Aug...62
Interfacing computers to the analog world—Part IV	Sep...72
Interfacing computers to the analog world—Part V	Oct...62
Interfacing computers to the analog world—Part VI	Nov...62
Interfacing computers to the analog world—Part VII	Dec...52
Those mysterious glitches	May...62
The ripple counter	Apr...58

VIDEO CORNER

Audio high-fidelity in VCRs	Mar...90
The automatic search function	Jun...64
Elements of video optics—Part I	Aug...64
Elements of video optics—Part II	Sep...68
Elements of video optics—Part III	Oct...64
Elements of video optics—Part IV	Nov...60
High fidelity in VCRs—Part II	Apr...60
Noise in the picture on playback	Nov...58
Operation of the Newvicon pickup tube	Jan...72
The playback story	May...64
Servicing VCR mechanical problems	Dec...64
Troubleshooting recording problems	Feb...60
The 2 million-pixel CCD image sensor	Jul...62

WHAT DO YOU KNOW ABOUT ELECTRONICS

Backward transistors—An update	May...50
Four-terminal networks	Sep...58
Hall-controlled motors	Jun...48
Kirchhoff's voltage law	Dec...42
Magnetostriction	Feb...56
Modulating pulses	Jul...48
Network theorems and laws	Aug...54
The Norton generator	Nov...42
Thermistor bridges	Apr...52
Thevenin's theorem	Oct...50
We get letters	Jan...54



What do you know about electronics?

Some ideas that work...and some that don't

By Sam Wilson, CET

"Every bum in town has an idea that won't work."—Lester Sumrall, TV preacher.

At first, I was insulted by that quotation. However, after thinking it over, I realized he did say *an* idea. I've have a lot of ideas that won't work.

Perpetual motion

When I was very young, I had an idea for running an electric motor by using self-generated power. It is illustrated in Figure 1. The motor turns the generator, and the output of the generator supplies the electric power for operating the motor.

The idea is ridiculous, of course, but you would be surprised at the large number of students who have come to me with the same thought.

Candle power

Another of my ideas that *wasn't* so wacky is shown in Figure 2. A candle heats a thermocouple and produces a dc output. The output is used to operate a radio.

I actually went to the point of making a prototype, and it works. However, before I was able to get it on the market,

Wilson is the electronics theory consultant for ES&T.

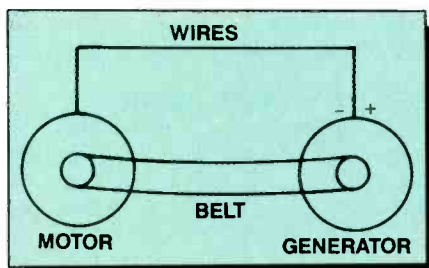

Figure 1. Here's a not-so-good idea for running an electric motor by using self-generated power. The motor turns the generator, and the output of the generator supplies the electric power for operating the motor.

I read about an improved version that was being used in north Sweden. The improved version used a kerosene lamp to heat the thermocouple. As with my version, the dc voltage was used to operate the radio. I decided to abandon my project because it wasn't new. (Another bad idea.)

I know that somewhere out there, an innovative reader is going to take this idea and turn it into millions. It would be an excellent emergency radio during hurricanes and other disasters when electricity has been shut off. You might even consider making it a small 2-way radio that could be used to get help.

Stopping corrosion

I once knew a guy who went to a lot of trouble to restore a 1940 Chevrolet. In those days, it wasn't for making money—he wanted to use the car. He had to replace the back fenders and he decided to use aluminum bolts. (I'm not the only one who has had bad ideas.)

In Akron, OH, they use a lot of salt on the streets in the winter. As you might expect, the aluminum and steel combination produced a galvanic action that ate the fenders.

That started me on the road to another great idea: If you could supply a reverse current to cancel the galvanic action,

you could stop the corrosion. This idea won't be needed for aluminum bolts in Chevy fenders. However, think about the problem of welds, hangers for mufflers...

Don't rush to your workbench with this one. It has already been done. At least, that's what I've heard. But maybe—just maybe—you can still get in on this idea.

The Thompson effect

The Thompson effect is illustrated in Figure 3. If you heat one end of a long conductor, there is a voltage across its ends. In a car, the exhaust system is made with a long conductor of electricity and is heated at one end. Can you use that electricity to provide the bucking current? It *might* be used to prolong the life of the exhaust system.

The linear modulator

A few years ago, I was sitting at the work bench of a good friend in Youngstown. He had a test going that was curious to say the least. His setup is shown in Figure 4.

He wanted a modulated signal. Without thinking about what he was doing, he connected two signal generators across a linear resistor. I asked him what was going on, and as he started to ex-

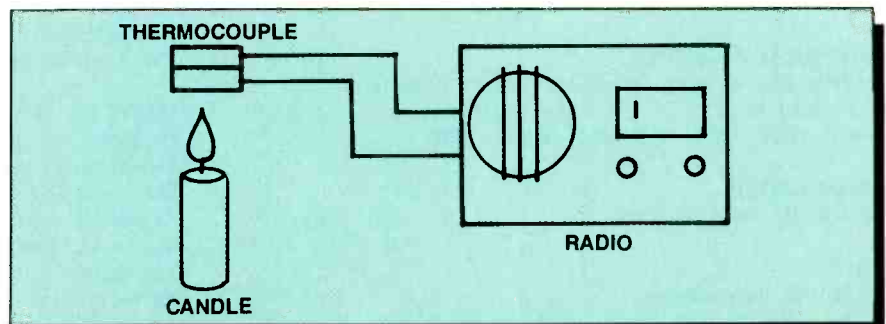

Figure 2. One idea that could come in handy during a power outage is using a candle to heat a thermocouple and produce a dc output. The output is used to operate a radio. An improved version used a kerosene lamp to heat the thermocouple.

plain, he immediately saw the error. We both had a good laugh. Another bad idea, but this time it wasn't mine.

Of course, you cannot heterodyne or modulate signals in a linear device. You must have a non-linear device or circuit. A transistor would have worked.

Let's take a look at amplitude modulation and one circuit that might be used to amplitude-modulate an audio fre-

quency signal. Figure 5 is a block diagram of an amplitude modulation system. The oscillator produces a high-frequency signal that will be used as the carrier frequency. The AF could be the voice information from a microphone in a radio studio. The two signals are combined in an amplitude modulator and then transmitted as a radio signal.

Figure 6 is a simple schematic

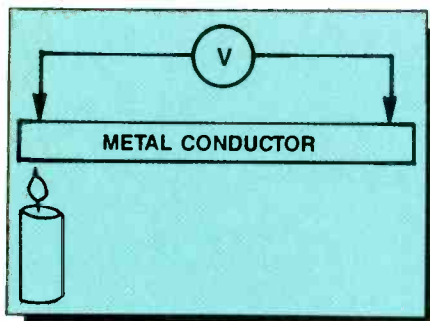

Figure 3. This figure illustrates the Thomson effect. If you heat one end of a long conductor, there is a voltage across its ends. In a car, the exhaust system is made with a long conductor of electricity and is heated at one end. Can you use that electricity to provide the bucking current? It *might* be used to prolong the life of the exhaust system.

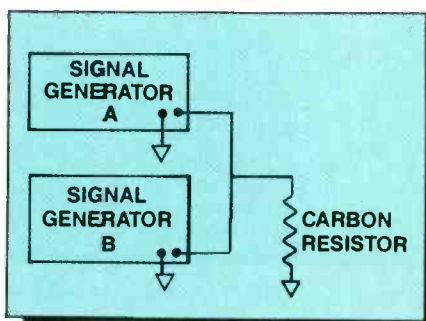

Figure 4. In this setup, the desired outcome was a modulated signal. Without thinking about what he was doing, the experimenter connected two signal generators across a linear resistor. The problem is, you cannot heterodyne or modulate signals in a linear device. You must have a non-linear device or circuit. A transistor would have worked.

quency signal. The audio frequency information is coupled to the collector of the transistor via transformer T_1 . The audio signal induced in the secondary of the transformer adds to or subtracts from V_{CC} . The result is a collector supply voltage that varies in step with the audio signal.

Capacitor C_1 and resistor R_1 make up the transistor input circuit, and the combination of capacitor C_2 and transformer T_2 forms a resonant circuit with values chosen so that it is resonant at the frequency of the RF input.

The combination of a supply voltage varying at the RF frequency and the collector supply voltage varying at the audio frequency rate results in an output of a radio frequency signal, commonly called a *carrier*, that is amplitude-modulated by the audio signal.

Actually, the output consists of three frequencies. Let's say that the RF signal input is 1,000kHz and the modulating audio frequency is 5kHz. The output will then consist of a signal at 1,000kHz, one at 1,005kHz, and one at 995kHz.

Learn how to repair VCRs...

Read

Video Corner 

each month
in **ELECTRONIC**

Servicing & Technology

Presenting an affordable Light Box System.

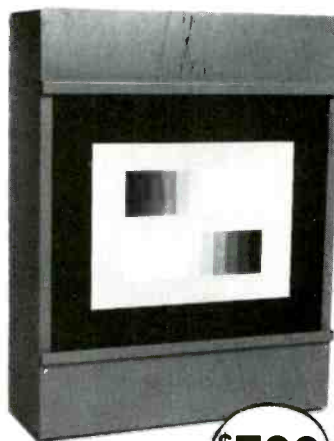

\$799

The method most manufacturers recommend

Model TR100 CB
Camera Light Box
with (2) transparencies

- (2) 3200^o Kelvin Lamps (meets mfr. spec.)
- 1-year conditional guarantee
- Transparencies mounted in acrylic with optical scratch-resistant surface
- 11-step gray scale transparency
- 7-Bar color transparency
- All orders are shipped within 72 hours, U.P.S.

NOTRONIX (313) 939-2740

P.O. Box 77103 • Sterling Hts., MI 48077

Circle (17) on Reply Card

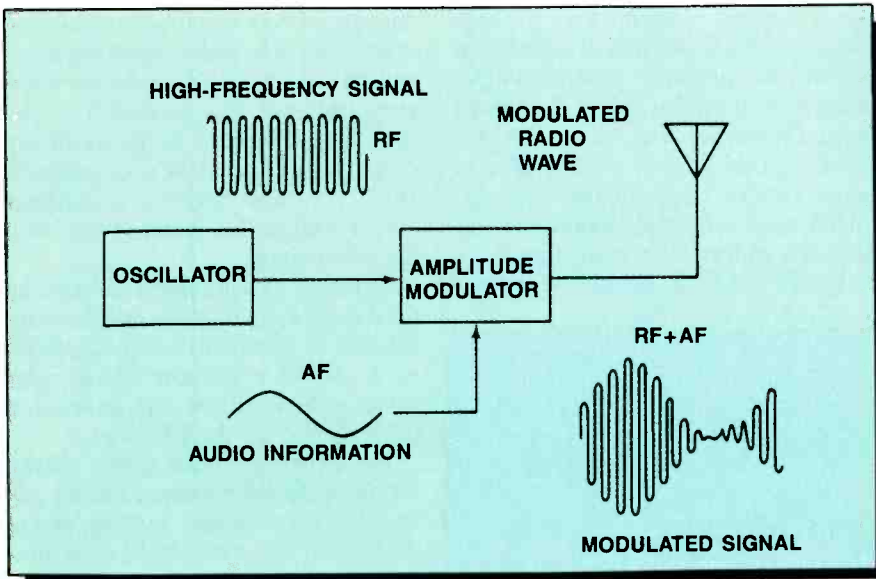

Figure 5. Combining an RF signal with an audio frequency signal in a modulator produces an RF signal that is modulated by the audio frequency.

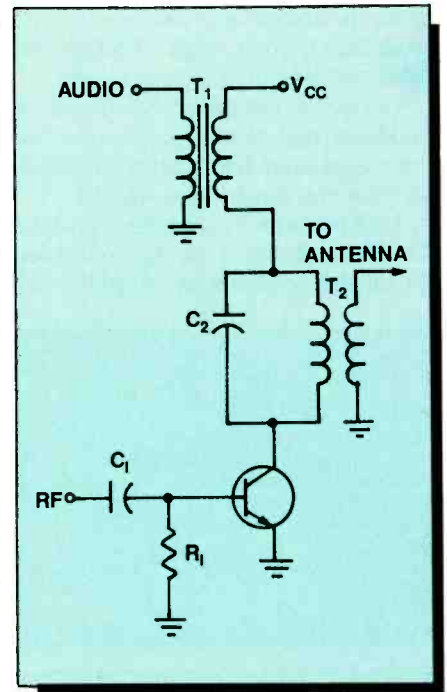

Figure 6. One way to achieve amplitude modulation is to use the RF signal as the input signal to a transistor amplifier and to vary the supply voltage of the circuit with the audio signal. The output will be an amplitude-modulated signal.

Figure 7. Amplitude modulation actually produces three frequencies: the carrier signal, the sum of the carrier and modulating signals, and the difference between the carrier and modulating signals.

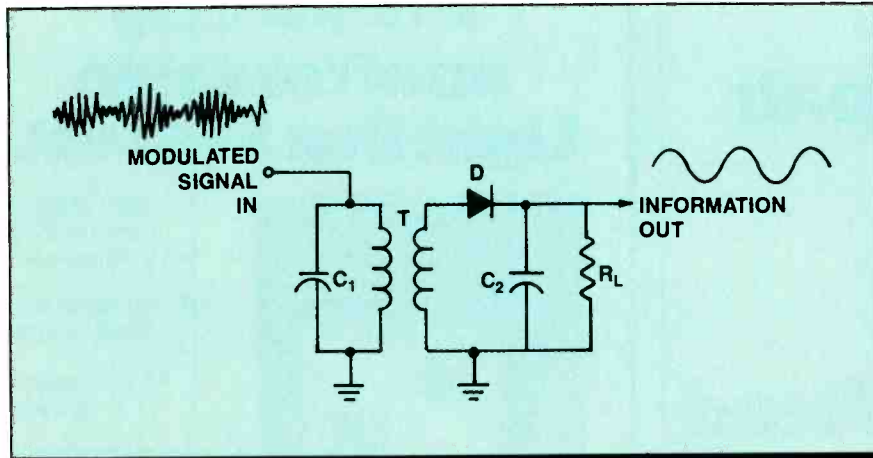
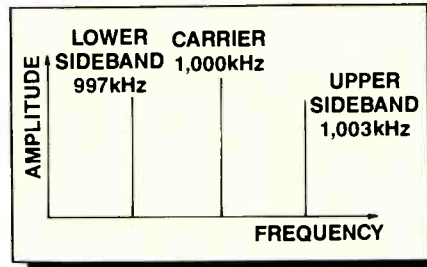

Figure 8. A diode may be used as the key element in a demodulating or detection circuit.

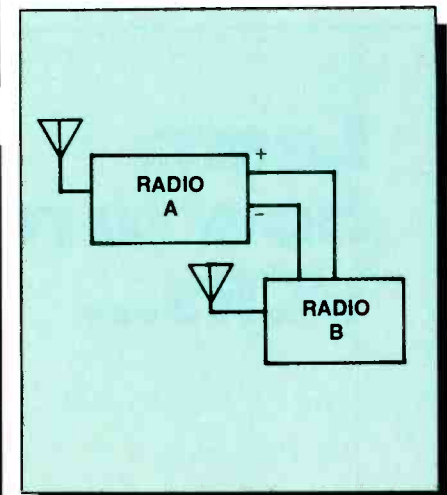

Figure 9. In this circuit, radio A is a crystal radio tuned to a strong local station. The signal is rectified and filtered. The resulting dc voltage is used to operate radio B, a 1-transistor radio.

Figure 7 shows what a spectrum analyzer would display if this signal were used as input to it. The upper and lower frequencies are called the upper and lower sidebands, respectively, and the frequency difference between the two is the bandwidth of the signal.

For you to hear the audio signal at the receiver, it must first be demodulated or detected. Just as you can't use a linear device to perform modulation, you can't

use a linear device for demodulation. Any non-linear circuit component such as a diode or a transistor can be used to perform the detector. Figure 8 shows one possible circuit used for demodulating a modulated signal.

Self-powered radio

I once designed a circuit that worked very well. What made it a bad idea is the fact that it doesn't seem to have any

practical use. This circuit is illustrated in Figure 9.

Radio A is a crystal radio. It is tuned to a strong local station. The signal is rectified and filtered. The resulting dc voltage is used to operate radio B, a 1-transistor radio.

If there is no strong local station, the probes can be stuck into a lemon or a glass of 7-up. That gives enough voltage to operate radio B.

Servicing the compact disc player—Part IV

By Martin Clifford

This is the fourth part in a series on servicing compact disc players. Part III described trouble symptoms and some simple cures. Part IV will cover modification procedures.

From time to time, manufacturers will issue modification procedures, which are suggested in order to enhance some feature or function of a specific model of a CD player. Figure 1 is a modification for enhancing tracking stability. Such changes can be made when the CD player is brought in for servicing.

Failure of parts

Given enough time, all parts may fail and there are no exceptions. There are different kinds of failure. A part may become completely defective, or it may change its electrical characteristics so that operation becomes intermittent. All parts are considered as having a figure

of merit, a determination based on a statistical analysis of a previous history of failure. This type of analysis allows manufacturers to anticipate player operating problems and is also an aid in controlling parts inventory. The figure of merit is sometimes referred to as the mean time between failures and is abbreviated as MTBF. Transformers have the highest failure rate, followed by quartz crystals, transistors, capacitors, ICs and variable resistors.

Failures of CD players do not follow a straight-line graph. Most failures occur when the item is either brand new or when it has been used for a long time.

Failure of brand new units may be caused by the use of parts that have barely passed electrical inspection tests in the factory. It does not take much of a change in electrical characteristics to result in compact disc-player failure or poor operation. Old-age failure occurs because some parts inevitably will wear out due to temperature, humidity, vibration and improper handling.

Often enough, the servicing problems of a CD player are simple and are of the type described in the preceding articles. These troubles do not require opening the player, which is a waste of time if the difficulty is caused by something external to the unit.

Flowchart analysis

Every CD player can be considered to be a 2-part component. One section is involved with data flow (by data we mean the audio signal, whether that signal is in binary form or analog). The other part of the CD player consists of circuits in the control-signal flow path.

Narrowing a servicing problem to one of these areas involves making a number of decisions to find the defect through a process of elimination. This task can be accomplished with the help of a flowcharting technique, a method commonly used by computer programmers as an initial step in the preparation of a computer program.

Figure 3 is a flowcharting worksheet. It is a preprinted form available in some art stores or computer servicing outlets and consists of 50 blocks of five rows and 10 columns. Each block is identified by a letter followed by a number, so any block can be quickly identified.

A flowchart of all the possible problems that could occur in a CD player would be complicated. The one shown in Figure 2 is just a small portion of an overall flowchart.

Not all servicing flowcharts are alike. Those followed by factory servicing technicians (see Figure 2) make strong use of part number or reference numbers. These charts are intelligible only to those supplied with lists of such numbers identifying what these numbers represent. For in-factory service technicians, servicing is much easier than for those who do general electronic repairs. They can identify the parts, the

Continued on page 58.

Clifford, a freelance writer, has published more than 75 books on electronics.

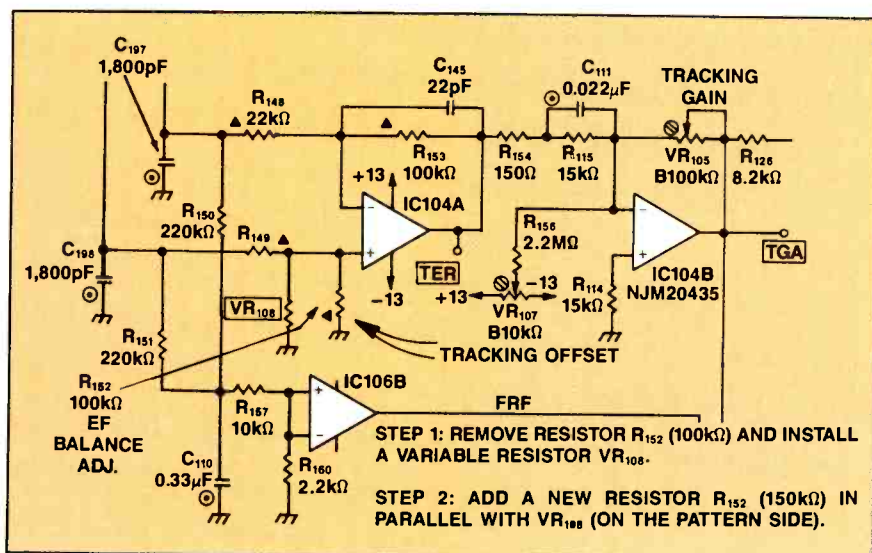

Figure 1. Manufacturers sometimes issue modification procedures to enhance a feature or function. This modification enhances tracking stability. (Courtesy of Yamaha Electronics Corporation, USA.)

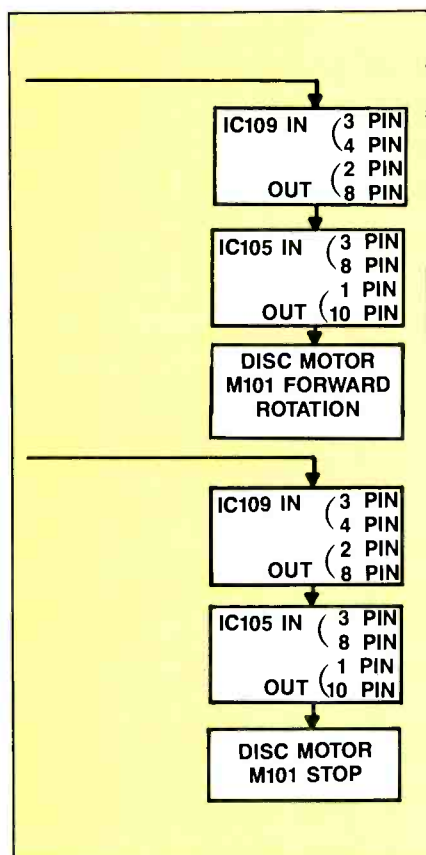

Figure 2. This portion of a flowchart shows the difference between flowcharts followed by factory servicing technicians and those used by general servicing technicians. This flowchart uses part numbers or reference numbers and is intelligible only to factory servicing technicians supplied with lists identifying what these numbers represent.

Table 1
Flowcharting abbreviations

AFC	automatic frequency control
DD	disc detection
DM	disc motor
DT	disc tracing
EFM	8-14 modulation
FCS	focus-in operation signal
FEO	focus-error output
FES	focus-error signal
FRT	focus-error-on confirm signal (focus refraction)
FCZ	focus-zero correction
H	H voltage
PLL	phase-lock loop
SL	slice level
SVC	servo controller
SYNC	synchronization
T	clock pulse
TEO	tracking-error output
TG	tracking gain
TH	tracking hold
TR	transistor
TROF	tracking servo off
VCO	voltage-controlled oscillator

Continued from page 57.

replacement units are readily available and a servicing procedure is set up for them. They also work only on CD players made by their company.

The type of flowchart used by general service technicians is quite different because each block is more clearly identified. (See Figure 4.) These flowcharts often use abbreviations such as D/A, PLL, Sync, AF, RF, but most of these are either well-known or can be interpreted. If a service technician's flowchart does use part numbers, they are often supplied as supplementary information to allow easy ordering of replacements.

Flowchart symbols

About 20 different symbols are used by computer programmers for the

FLOWCHARTING WORKSHEET

PROGRAMMER: _____		PROGRAM NO.: _____		PAGE: _____	
CHART ID: _____		CHART NAME: _____		PROGRAM NAME: _____	

A1

A2

A3

A4

A5

B1

B2

B3

B4

B5

C1

C2

C3

C4

C5

D1

D2

Figure 3. Blank flowcharting worksheets, which are often available in art stores or computer servicing outlets, consist of 50 blocks of five rows and 10 columns. Each block is identified by a letter followed by a number, so any block can be quickly identified. (Courtesy of Programming & Systems.)

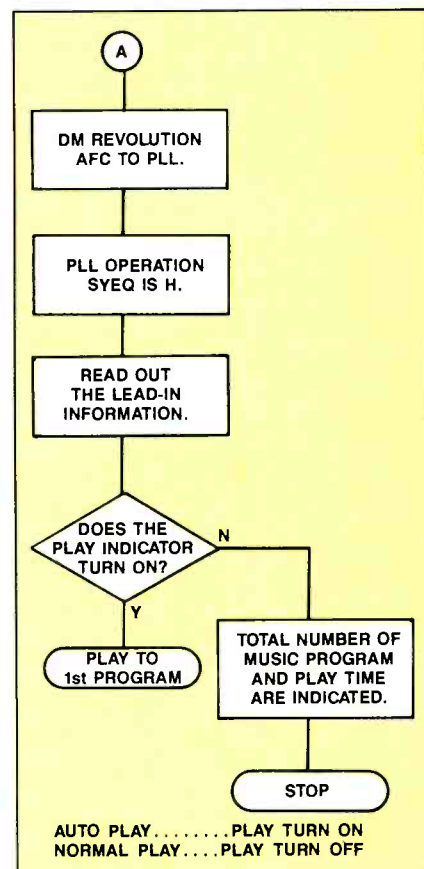

Figure 4. In flowcharts for service technicians not factory associated, each block is more clearly identified. These flowcharts often use abbreviations that are either well-known or can be interpreted. If a service technician's flowchart does use part numbers, they are often supplied as supplementary information to allow easy ordering of replacements.

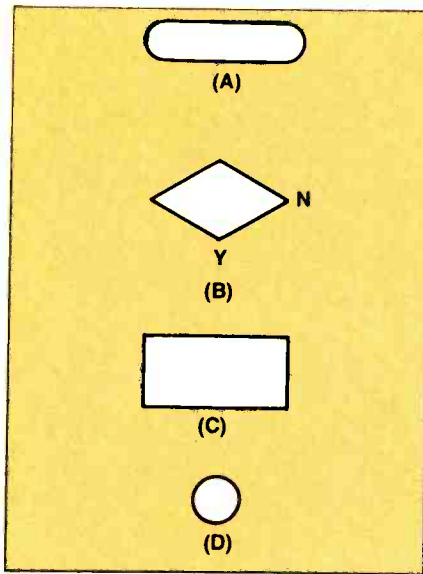

Figure 5. About 20 different symbols are used by computer programmers for the preparation of their flowcharts, but for the most part, a CD-player flowchart requires only these four.

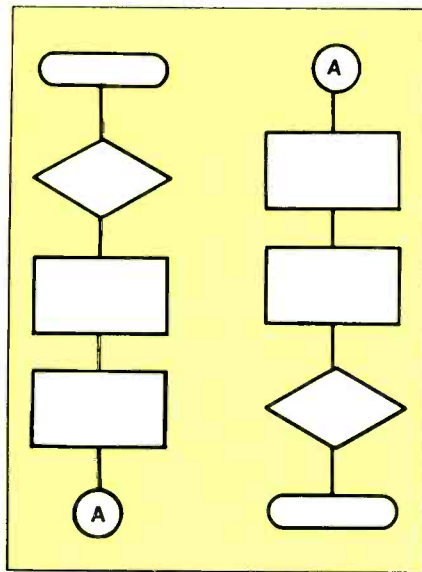

Figure 6. A connector symbol indicates a connection to another part of the CD-player servicing flowchart. The movement or flow in this figure is from A on the bottom left to A at the top right.

preparation of their flowcharts, but for the most part, a CD-player flowchart requires only four (Figure 5).

The top symbol is a terminal symbol used to indicate the start or end of an action. It could represent turning a compact disc player on; later, in the same flowchart, it might indicate turning the CD player off. It can also be used to indicate the start of any action, such as the beginning of play of a particular track. The terminal symbol is often the first and last symbol used in a CD player servicing chart, but occasionally it can be found elsewhere.

The second, diamond-shaped symbol is the decision symbol and is accompanied by the letters Y (yes) and N (no). With a no answer, the flow of action follows one path; with a yes answer, a different path is followed.

The third symbol has the outline of a rectangle and is a processing symbol. The wording inside this symbol indicates some action. This action could be focus search, disc rotation or an indicator turning on, among others.

The final symbol, a small circle, is known as a connector. A letter generally is written inside the circle to indicate a connection to another part of the CD-player servicing flowchart. (See Figure 6.) The connector marked A on the left side is joined to the other connector,

also marked A, on the right side.

Each symbol is connected by a straight line called a *flowline*. These lines indicate the path to be followed in a servicing procedure.

The symbols used in a servicing flowchart can be drawn free-hand, but a better method is to use a template. Because not all compact disc players are alike, it is helpful to prepare a servicing flowchart for all the CD players you service. Even if you can depend on your memory, having a set of flowcharts handy can shorten servicing time.

Flowcharting abbreviations

Room within each flowcharting block is limited, so abbreviations are commonly used. Unfortunately, there is no standardization for these abbreviations, and those used in the servicing flowchart of one manufacturer may not correspond to those used by other manufacturers. The list of abbreviations in Table 1 is typical.

The question of which flowchart to use will depend on the specific trouble symptoms. Based on these, the flowchart may be simple or detailed and lengthy. In some instances, more than one flowchart may be required if the symptoms are in different areas of the CD player. The faults may or may not be related.

ES&T

MOVING?

If you're planning a move in the near future, don't risk missing an issue of *Electronic Servicing & Technology*. Please give us 6-8 weeks notice if you're planning on changing your address. Just write in your new address below and mail this coupon, WITH YOUR SUBSCRIPTION MAILING LABEL, to:

ELECTRONIC
Servicing & Technology

Subscriber Services
P. O. Box 12901
Overland Park, KS 66212

Name _____

Address _____

City _____

State _____ Zip _____

Now You Can Learn Electronics
From VHS Video Tape!!!
UCANDO Now Has Four Video
Tapes Designed For The
Electronic Enthusiast.

ELECTRONICS AND YOU—PART ONE DC
PRICE \$32.95

You will learn about Series circuits, Parallel circuits, the combination of Series-Parallel circuits, Ohms Law, Voltage, Current and Resistance as well as how to use the Digital multimeter.

ELECTRONICS AND YOU—PART TWO AC
PRICE \$32.95

You will learn about AC theory, Coils Transformers, Capacitors, Filter circuits and how they are used in actual circuits.

VCR MAINTENANCE AND REPAIR
PRICE \$32.95

This tape was designed for the average VCR user. No special tools or schooling are required for this tape. You will learn how to clean the entire tape path in the VCR as well as how to replace some of the belts in the VCR.

INTRODUCTION TO VCR REPAIR
PRICE \$59.95

You will learn how the VCR Processes the Luminance, Chromance and Audio signals in the VCR, in both the playback and record modes, you will also learn about the Servo systems used to control the Capstan motor and the Video Drum Cylinder. This tape also covers many more aspects of the VCR.

ORDER YOUR TAPES NOW!

VISA and MASTER CARD are accepted.

CALL: (513) 548-6113 or mail check or money order top:



P.O. Box 386
Greenville,
Ohio 45331

Circle (19) on Reply Card

Understanding the effects of software

By Conrad Persson

Troubleshooting a computer has many of the same elements as troubleshooting any other consumer-electronic product. There are the circuit components, the power supplies, the electromechanical devices like switches, motors, etc. A computer is unique in one respect, though, in that it uses software programs. In fact, a computer is said to be nothing but a worthless pile of transistors without software.

Actually, come to think of it, any consumer-electronic product is worthless without "software." If you turn on a TV set when there are no programs on, you get a blank screen. If you turn on a stereo system when there's no radio station on or record or tape playing, you get nothing. The broadcast program or the videotape is the software.

In the case of most consumer-electronics products, there are sometimes occasions where a problem with programming is not obvious—a broken wire at the antenna or an interruption of the cable service—and the first indication may be that the problem is in the hardware. Usually, though, a little program substitution like switching to another station, hooking up a VCR or changing over from the cable to an antenna for local broadcast will isolate the problem to the TV or stereo or the program source.

Unfortunately, in the case of a personal computer, when a software problem poses as a hardware problem, the solution to the problem is often not as straightforward as it is when it's a soft-

ware problem with an electronics entertainment product.

Asking the right questions

The point has often been made that the servicing technician should always ask the customer or operator for a description of the problem, including exactly under which conditions the problem occurs. This is especially true



Questions to ask

- Does this problem occur no matter what software you are using or only with a specific program or programs?

- What software?

- Under what conditions does the problem occur?

If the program is not operating, have the operator load the program and show you exactly what he was doing when the problem occurred.

with computer problems. Before beginning any diagnostic procedure, the technician should ask the following questions, or variations of them:

- What exactly is the nature of the problem?

- Does it occur with all software or only with certain programs?

- Exactly what sequence of keystrokes were you going through when the problem occurred?

One of the benefits of this kind of questioning is that, if the problem resulted in an apparent loss of data, the computer technician may be able to help the operator retrieve the data as well as saving himself hours of futile troubleshooting.

If it turns out that the problem occurs only with certain software programs, this symptom tends to indicate that it's a software or operator problem. This is where a familiarity with software is important. Of course, the fact that a problem only occurs with certain software doesn't necessarily rule out a hardware problem; it could be that the program exercises the hardware in a manner in which no other software used by the operator does. This is a less likely possibility than that the problem is software-related or caused by operator error.

Here are a couple of examples of software glitches that have occurred in the ES&T offices. The glitches might have caused a servicing technician a problem and resulted in loss of data if he wasn't somewhat familiar with the software. For example, when using the XyWrite word processing program by XyQuest, some of the editors would suddenly find themselves with a blank screen. Because most of them had not yet gotten used to saving their work frequently, they thought that somehow their hard work had just evaporated.

In this type of situation, if a servic-

Persson is editor of ES&T.

ing technician with no knowledge of software considerations had come onto the scene and began hardware troubleshooting, he would not have found the problem (it was not a hardware problem). Even worse, he would have irretrievably lost the data as well.

On the other hand, a careful questioning of the operator in this case led not only to the retrieval of the information but also to the conclusion that there really was no problem at all.

Here's what had happened: The operator had intended to press the control (CTRL) key and, while holding it down, also press the 7 key. In XyWrite, this combination of keys causes characters subsequently typed in to be superscripts. However, the SHIFT key is directly above the CTRL key on the IBM PC/XT keyboard, and it is very easy to accidentally press both the SHIFT and the CTRL key at the same time. In the XyWrite program, when the operator presses SHIFT-CTRL and a number between 1 and 9, the computer presents another "window."

XyWrite allows the user to operate on as many as nine documents separately at the same time. Each document is in RAM memory, but only one shows up on the screen at a time. The operator can switch from document to document. Each document is said to occupy its own "window." What had happened is that, by pressing SHIFT-CTRL-7, the operator had, instead of calling for a subscript, moved to window 7. There is no evidence on the screen that this has happened. All the words just disappear as if by magic.

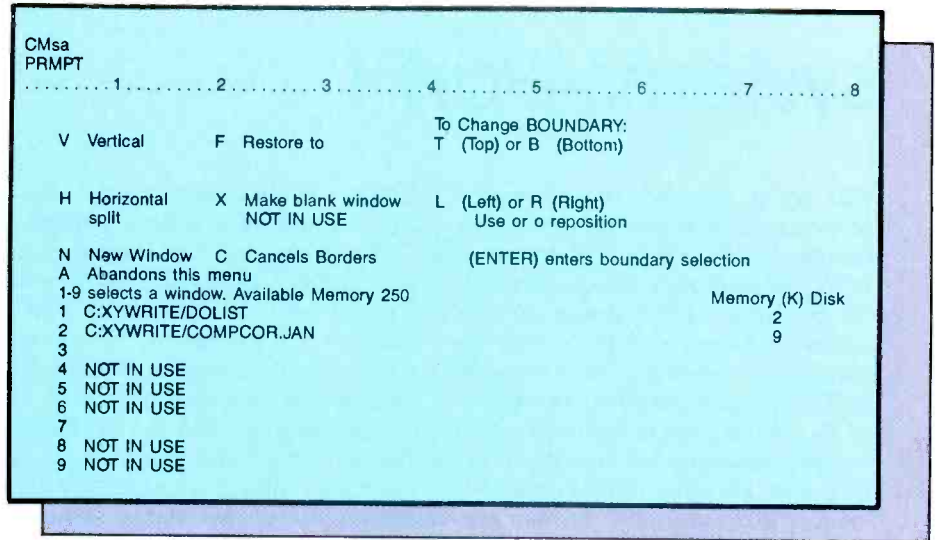

Figure 1. In XyWrite, a screen that goes blank unexplainably may mean the operator has accidentally entered another window. CTRL-F10 brings up the window menu. A highlighted number shows you what window you're in.

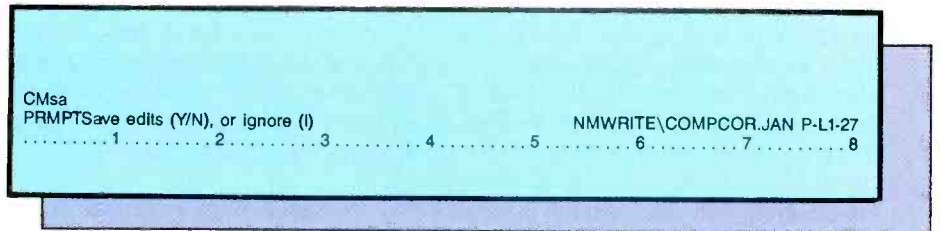

Figure 2. In the XyWrite software program, pressing ALT-N accidentally instead of SHIFT-N brings up this prompt. If you press N again, the document disappears.

In this case, the operator was fortunate: The technician was familiar with the program. Before turning the computer off, he carefully questioned the operator. "What were you doing just before the information on the screen disappeared?" Knowing that there is a menu that shows the status of the windows, the technician pressed CTRL-F10. The fact that the number 7 was emphasized told him that the computer was in window 7. Simply pressing the number 1 in the menu mode returned the program to window 1, where the original document had been all the time.

Another problem has occurred using this particular software. Pressing ALT and the letter N causes the message "SAVE EDITS (Y/N), OR IGNORE (I)." If the operator actually intended to type an upper-case N by typing SHIFT-N, he probably wouldn't even notice the message up on the command line and

will press SHIFT-N again. Now there's a problem. When the operator pressed N again, which signifies "no" for this operation, the program doesn't save the document but does erase it from memory. Again, only careful questioning of the operator and familiarity with the software can let the servicing technician know that this is an operator problem, not a hardware problem.

So when you are called to service a computer, part of the problem is to determine if the problem is a hardware problem or a software problem. The source of the problem frequently is obvious, but in those cases where it is not obvious, it can be a real bear.

In those cases, it's important that you be passingly familiar with the general ideas of programming and some of the most popular software programs as well as DOS.

ES&T

Troubleshooting VCR front loading systems—Part I

This series describes procedures for servicing the front loading system on a specific brand and specific models of VCRs. However, the methods discussed, the operation of the device and the precautions mentioned should have applications to almost any brand or model of VCR. This first part gives an overview of the circuitry and its operation. Next month's installment will describe the actions that take place when a cassette is loading and the troubleshooting procedures to use when loading doesn't occur properly.

All Mitsubishi 1985 front-loading VCRs use the same basic tape deck and cassette/tape loading mechanism. The drive for cassette loading is supplied by the capstan motor, and the loading motor supplies drive for tape loading. Both processes are monitored by two status switch assemblies: the FL switch assembly, which monitors the cassette loading operation (drawing the cassette into the VCR until it is seated on the reel

This information was adapted with permission from the article "VCR Front Loading Troubleshooting," which appeared in Volume I of *The Best of the Expander*, published by Mitsubishi.

hubs); and the mode switch, which monitors the tape-loading operation.

The cassette- and tape-loading operation is the responsibility of two individual motors; a mechanical mechanism, which actually moves the cassette and withdraws the tape from the cassette; the cassette housing; and the mechanical control circuitry that generates the appropriate control commands from data furnished by the status switches. Because the operation involves so many different parts, a problem in this area of the VCR may create some confusion. Remember that the capstan motor supplies drive for cassette loading, so a defect in the capstan motor/drive circuitry, which would simply result in no tape movement on earlier model VCRs, will first appear as a cassette-loading problem on current model VCRs.

Capstan motor drive

If you encounter a cassette-loading problem, the capstan motor and capstan motor drive circuit should always be checked before you become involved in the status switches and the mechanical mechanism. A defect that renders the

Table 1
Nomenclature for the
STK-6962 IC

Model	Capstan drive IC
HS-306UR	IC5A5
HS-316UR	IC5A4
HS-317UR	IC5A4
HS-400UR	IC5A4
HS-710UR	IC5A5

capstan motor inoperable will first appear as an inability to load a cassette.

All the 1985 Mitsubishi VCRs use an STK-6962 IC as the capstan motor drive IC. The schematic nomenclature for this IC does vary, however, from model to model. Table 1 lists the various models involved and the nomenclature of the capstan drive IC used for each model.

Capstan drive circuitry

Figure 1 illustrates a simplified version of the capstan drive circuitry and the circuits involved in generating the required commands for the model HS-400UR. IC5A4 is the capstan motor drive IC. When no drive is directed to the capstan motor, both of the IC outputs at pins 3 and 6 are low. When a high is generated at pin 3, the capstan motor rotates in a forward direction and a high at pin 6 results in reverse rotation. Forward drive is input to the IC at pin 7; reverse drive is input at pin 2.

In a mode that requires no capstan rotation, such as when a cassette is not loaded into the VCR or when a cassette is loaded but the VCR is in the stop mode, both the inputs at pins 7 and 2 are held low by the conduction of Q4N1 and Q4N2, respectively. The two capstan directional command lines from the mechanical control, microprocessor IC5A0, CP-FWD and CP-REV are normally high, holding Q4N1 and Q4N2 in conduction.

If an operational mode requires forward capstan rotation, the mechanical

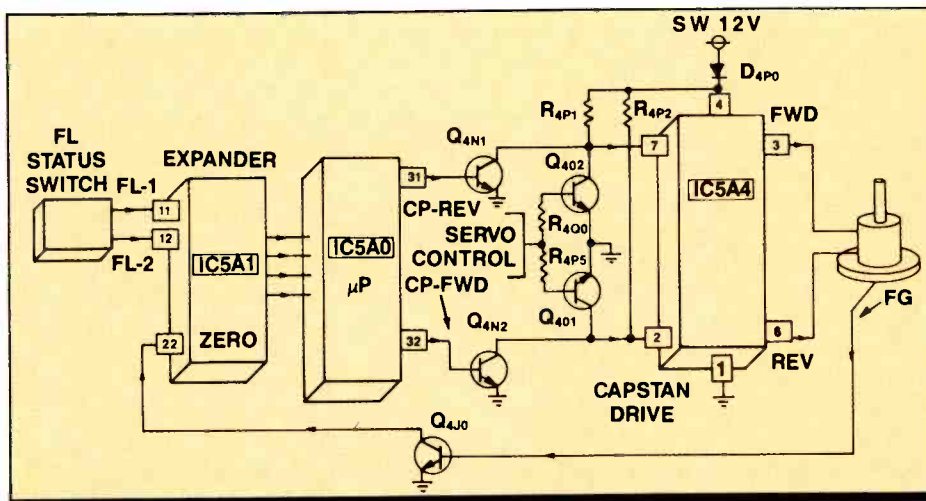

Figure 1. This simplified version illustrates the capstan drive circuitry and the circuits involved in generating the required commands for the model HS-400UR.

control microprocessor must be constantly informed as to the status of capstan motor rotation. To achieve this, a sample of the capstan FG signal is directed via Q4J0 to the ZERO input of the expander, IC5A1, in the mechanical control circuitry. Because the FG signal is generated only if the capstan motor is rotating, the presence or absence of the FG signal effectively informs the microprocessor as to the status of the capstan motor.

If the microprocessor IC5A0 generates a capstan rotation command and for some reason the capstan motor does not rotate, no FG signal will be generated. The absence of an FG signal at the ZERO input of the expander, IC5A1, is sensed by the microprocessor, which responds by removing the drive command to the capstan drive circuitry. Should this occur, the microprocessor will not generate a second capstan rotation command unless IC5A0 is reset by completely disconnecting the VCR from the power source, then reapplying power.

Due to this characteristic, if the VCR will not accept a cassette due to the inability of the capstan motor to rotate, the commands and drive to the capstan motor circuitry will be momentary only. Therefore, when troubleshooting the circuitry, the technician has approximately three seconds in which to monitor capstan drive commands and voltages when a cassette is manually inserted. To regenerate the commands, the microprocessor must be reset by disconnecting the VCR from the power source, then reapplying power. After resetting the microprocessor, the commands may be regenerated once by inserting and holding the cassette in the VCR.

Cassette loading

To aid in isolating a defect in the capstan drive circuitry, the sequence of events occurring during a normal cassette-loading operation are described here.

1. As the cassette is manually inserted, the FL status switch assembly rotates.
2. Rotation of the FL switch generates a low in the FL-1 status line, which has no significance at this point—it is merely a presetting action.

3. Continued rotation of the FL switch causes the FL-2 status line to go low, and the microprocessor responds by generating a low on the CP-REV line.

4. The low on the CP-REV line turns off Q4N1, allowing forward drive at pin 7 of IC5A4 from the 12V supply via R4P1.

5. The positive voltage at pin 7 generates an output at pin 3, driving the capstan motor in a forward direction.

6. The rotation of the capstan motor drives the front loading mechanism, and the cassette is drawn into the VCR.

7. Because an FG signal is generated when the capstan motor rotates, the microprocessor does not remove the low on the CP-REV line, and the motor drive continues.

8. The FL switch continues to rotate as the cassette is drawn into the VCR.

9. When the cassette is resting on the reel hubs, the FL switch generates a high on the FL-1 status line.

10. The microprocessor responds by driving the CP-REV line high, removing drive to the capstan motor. Remember that if the capstan motor does not rotate, the drive commands will only be generated once. To reproduce the drive commands, the VCR must be disconnected from the power source, then reconnected to reset the microprocessor. This makes tracing the capstan drive somewhat more time consuming, but it is necessary to determine where the drive command is lost.

The expander is a monthly publication published by Mitsubishi and sent to its authorized service centers. It is not available to other servicers. The annual volumes of *The Best of the Expander* are available for general sale, however. If you would like more information on these volumes, write to:

Mitsubishi Electric Sales America
 Technical Services Department
 5757 Plaza Drive
 PO Box 6007
 Cypress, CA 90630-0007 **ES&T**

PRIME ELECTRONICS CO.

For All Your Electronic
 Parts & Accessories

WE'RE THE ONE . . .

- With over 10,000 Electronic Products
- With Everyday LOW Prices and Volume Discounts
- With 100% Guarantee On All Products
- With the PRB LINE of Replacement Belts and Tires

For Your Free Copy of Our
 New Catalog Call Toll-Free
1-800-558-9572

In Wisconsin 1-800-242-9553
 or for 24 Hour Ordering Call . . .

FAX: 414-473-4727



"First in Quality And Service"

PRIME ELECTRONICS CO.

P. O. Box 28
 Whitewater, Wisconsin 53190

Circle (20) on Reply Card

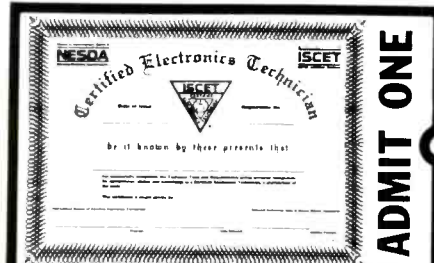

Your Ticket To

SUCCESS

Over 25,000 technicians have gained admittance worldwide as certified professionals. Let your ticket start opening doors for you.

ISCED offers Journeyman certification in Consumer Electronics, Industrial, Medical, Communications, MATV, Radar, Computer, and Video. For more information, contact the International Society of Certified Electronics Technicians, 2708 West Berry St., Fort Worth, TX 76109 • (817) 921-9101.

Name _____
 Address _____
 City _____
 State _____ Zip _____

Send material about ISCED and becoming certified.

Send one "Study Guide for the Associate Level CET Test!" Enclosed is \$5 (+ \$1 postage).

Breakthroughs pave the way for superconductor devices

Researchers at Toshiba have recently achieved three breakthroughs in superconductor technology, paving the way for future superconductor devices. The technology, although experimental, will help expand the prospects of superconductor applications.

A little history

Since the beginning of this century, scientists have known that some materials completely lose electrical resistance when cooled to a temperature of almost absolute zero, or minus 273°C. This phenomenon is called *superconductivity*, and scientists have tried to apply it to various equipment.

During the last two years, researchers have made major advances by creating new materials that become superconductive at temperatures far higher than had been thought possible. These materials

become superconductive when cooled by liquid nitrogen, which is much cheaper and easier to handle than liquid helium, the coolant previously used. These *high-temperature superconductors* make practical applications more feasible.

One of the most challenging targets of this technology is the application of these materials to new electronic devices that would surpass present semiconductors in speed while consuming much less power.

Applying the technology

The most fundamental and important technology in applying superconductors to electronics is to make flat, uniform thin films and join them with other materials. However, there are many problems with present high-temperature superconductors processed into thin films: uneven surface, heat required during the production stage, and surface

deterioration. These problems have led to a loss of superconductivity.

As a step toward the future application of superconductors in electronics, Toshiba researchers have recently achieved three breakthroughs:

- a new technology to make a flat and uniform layer of superconductor thin film without annealing.
- a solution to the problem of deteriorating surface of superconductor thin film.
- an experimental junction of insulator and lead on the surface of superconductor thin films, through which *superconducting tunnel effect* has been observed.

Eliminating annealing

Until now, superconducting thin films have been made using an annealing process, which reaches a temperature of approximately 900°C and results in a rough surface that is difficult to join to other thin-film materials. Also, the superconducting properties of the surface of the film deteriorate due to contact with air and moisture.

Toshiba has developed a new fabrication method called "multi-target reactive sputtering," which makes annealing unnecessary. In this method, yttrium, ceramic materials of barium and copper, and metallic copper are targets that are bombarded with an argon-oxygen gas mixture. The argon ions are excited by electrical energy, which strikes atoms from the target and forms layers of thin film up to 700 millionths of a millimeter onto substrates preheated to 560°C.

By controlling the energy of argon ions, the method can accurately control the amount of atoms of yttrium, barium and copper in a 1:2:3 proportion to form the optimum compound. Because of the proportions, the newly formed material requires no annealing to become superconductive.

Protecting the thin-film surface

To prevent the surface of the thin film

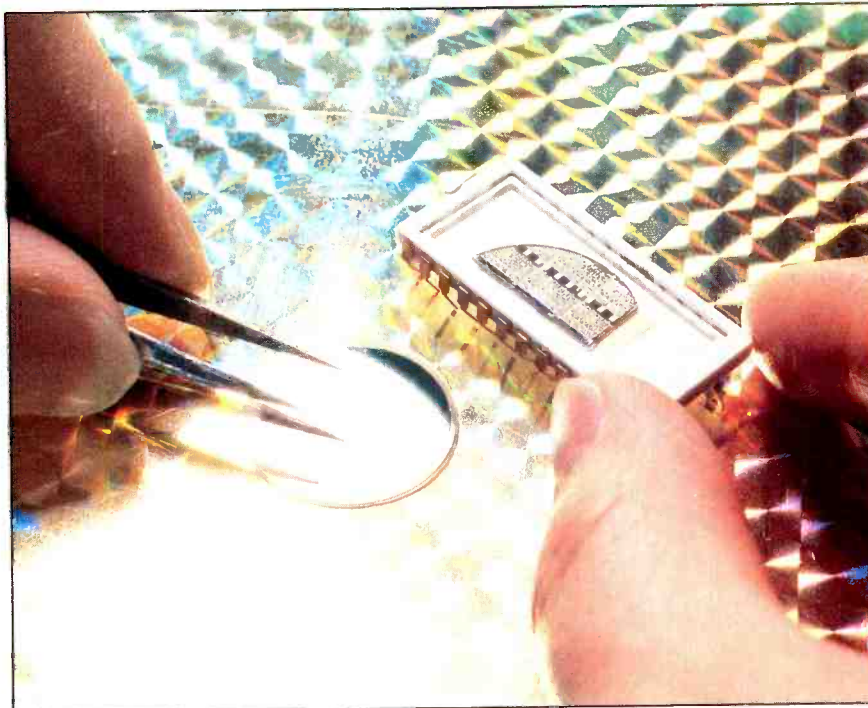

A superconductive thin film coated with silver. (Courtesy of Toshiba)

Literature

Instruments catalog

A supplement to *Contact East's* general catalog offers test and measurement instruments from many top companies. Products included in the catalog are DMMs, oscilloscopes, probes and accessories, BOBs, capacitance meters, VOMs, EPROM programmers, soldering supplies, inspection aids, precision hand tools and more.

Circle (125) on Reply Card

Test equipment catalog

Anasco has released its latest catalog of peak performance test and measurement equipment. The 48-page publication offers technical information, complete specifications and selection guides for hundreds of test, service and measurement products, including multimeters, calibrators, power supplies, frequency counters, function generators, chart recorders, scopes, break-out boxes and service supplies.

Circle (126) on Reply Card

Hand-held multimeter brochure

An 8-page brochure is available describing the next generation of *Fluke* hand-held multimeters. The brochure highlights the three new Fluke 80 Series multimeters: the full-featured 83, the higher-accuracy 85 and the top-of-the-line true-rms 87.

Circle (127) on Reply Card

Products catalog

The Tek Direct Catalog for Instruments, Accessories, and Services from *Tektronix* describes a sampling of the company's products and features the 200 and 2200 series portable oscilloscopes, the 1205 logic analyzer, accessories, software and training aids. Purchases made through the catalog are covered by a 30-day guarantee of satisfaction and are shipped postpaid within 24 hours.

Circle (128) on Reply Card

Components catalog

The 1988 *American Design Components* catalog provides information on thousands of items, including the company's full line of electronic/electromechanical components and computer parts and peripherals.

Circle (129) on Reply Card

ES&T

ES&T

from losing its superconducting properties and thus make the junction with other materials possible, the researchers added a layer of silver to the surface. The silver layer is formed on the superconducting thin film through vacuum evaporation, after which it is annealed at 500°C while being supplied with oxygen. This creates an oxidized silver layer that prevents oxygen from escaping from the thin film and prevents the effect of water vapor in the air.

The researchers have discovered that the silver layer on the film also exhibits superconductivity, although silver is not a superconductor itself. This effect is called *proximity effect*, and the two materials in conjunction can work as a single superconductor.

Fabricating the tunnel junction

The experimental tunnel junction, which showed superconducting tunnel effect, was fabricated using this superconducting thin film and lead (another superconducting material).

When two superconductors (in the form of thin films) are joined with an insulator between them (a tunnel junction), there is a flow of electric current through the layers in spite of the insulator. This is called *superconducting tunnel effect*, a phenomenon peculiar to superconductors. The most prominent characteristic of this tunnel effect is that, when electric current flows beyond a certain level, a large resistance suddenly appears, generating electric voltage. If the electric current decreases, the resistance gradually diminishes to zero, losing voltage. This characteristic can be used as a switch, digitally counting the appearance and disappearance of voltage as 1 and 0. Because electrons can move much faster in the superconductors, unhindered by resistance, the switching function is expected to work 10 to 100 times quicker than that of present silicon or gallium arsenide semiconductors.

ATTENTION TECHNICIANS

- ★ JOB OPENINGS
- ★ MONTHLY TECHNICAL TRAINING PROGRAM
- ★ BUSINESS MANAGEMENT TRAINING
- ★ LOW COST INSURANCE
- ★ CERTIFICATION
- ★ TECHNICAL SEMINARS

All of this in a nonprofit international association for technicians

FIND OUT MORE:



604 N. Jackson St.
Greencastle, IN 46135
317/653-8262

CONSOLIDATED ELECTRONICS

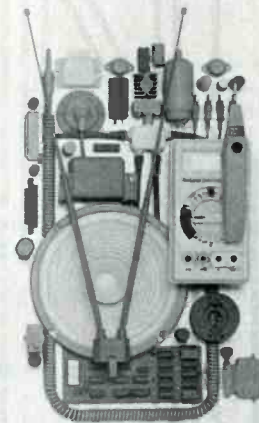

CONSUMER & INDUSTRIAL ELECTRONICS CATALOG • 17TH EDITION

THE ULTIMATE ELECTRONICS CATALOG.

Order your 260 page catalogue packed with over 10,000 money saving electronic parts and equipment. Send \$3.00 check or money order, or call 1-800-543-3568 today and use your Mastercard or Visa.
Consolidated Electronics, Incorporated
705 Watervliet Ave., Dayton, Ohio 45420-2599

NAME _____
ADDRESS _____
CITY _____
STATE _____ ZIP _____

Circle (18) on Reply Card

Readers' Exchange

Editor's Note: Readers' Exchange items are published in the order they are received. We are happy to offer this service at no charge to you, our readers, but we ask that:

- Items are typed (or legibly written).
- You include your name and address on the same page as your ad (envelopes and contents are often separated). Please also include your telephone number (specify if you don't want it published). Using your peel-off label is a good idea.
- You limit any ad to no more than three items. If space demands, ads will be edited to roughly four lines in the magazine.

WANTED

Case and keyboard for Commodore 64 (a junk C64 or one in pieces is acceptable); a C64 Rev.; an operational motherboard; schematic (unavailable from Sams); and a VIC1540, 1541 or equivalent drive, need not be operational. *Thomas Radigan, 264 Addison Road, Riverside, IL 60546.*

Good, used yoke for Sharp model SKC-1910A, part #RCILH13ICEZZ or equivalent. *Amado D. Ramos, 428 Wolford Drive, Spring Valley, CA 92077; 619-267-7673.*

Sylvania GTE, Sams 1503, model SD2769W; flyback trans. 5039287-1, D445 triad or 550 Thor-darson. *Luis Buiatti, 7017½ Seville Ave., Huntington Park, CA 90255; 213-585-7020.*

Knight 83YX137 AF generator with manual; Knight 83YX123 sweep generator; probe assembly for Knight 83Y135 signal tracer; Supreme's TV manuals 1, 2 and 11; and Tekfax volumes 100, 102, and 115-117. *Charles T. Huth, 229 Melmore St., Tiffin, OH 44883; 419-448-0007.*

A copy of the schematic and any other information pertaining to the Unimetrics Sea-Com 55 VHF transceiver. This chassis may be the same as the old Lafayette Radio discontinued model. *Walt Perna, 403 Apple Road, Newark, DE 19711; 302-368-3266.*

Hollow solder tips for Permax QRVPN. Also want to trade a B&K 1077B analyst for an RCA WV98C Volt Ohmst. *Paul Ashour, Rucker's Radio & TV, 5208 Pershing at Camp Bowie, Fort Worth, TX 76107; 817-738-6568.*

Schematic/service manual for a NUMARK model DM-1000 disco audio mixer, or address of company. Will buy or copy and return. *Jerry's Radio Service, 409 Oklahoma St., Shamrock, TX 79079; 806-256-3405.*

Power transformer for a Lectrotech TO-55 oscilloscope (or a TO-55 scope with good power transformer for parts). *Alvin Searles, 13057 Banfield Road, Battle Creek, MI 49017.*

Sony TC-250 reel-to-reel tape recorder for parts. *Dave LaPlante, 13A Walnut St., Potsdam, NY 13676; 315-265-4735.*

Schematic, cartridges and printer for Atari XL600. Must be cheap. Will pick up in Kenosha County, WI, and Lake and Cook Counties in Illinois. *Charles M. Kelly, 3336 Chatham, Waukegan, IL 60087; 312-623-2597.*

Hitachi V-509 or Tektronix 321/321A oscilloscope (these models only). *Marvin Loftness, 115 West 20th Ave., Olympia, WA 98501; 206-357-8336.*

Front and rear cabinet for RCA model JGR955W hotel TV. *Hawaiian TV, 1250 S. King St., Honolulu, HI 96814; 808-521-3838.*

Amperite ballast tube number 7H-10. *Paul Capito, 637 W. 21 St., Erie, PA 16502.*

Schematic for a Turner Plus 3 CB power mike. Call 517-224-8179. *John Teems, 407 W. Sickles, St. Johns, MI 48879.*

FM signal generator, 25MHz to 500MHz with 0kHz to 15kHz, Modulation Measurements 560, Motorola TI034B or similar. *Thomas L. Hanke, Hanke Electronics, 705 E. Kings Road, Tomahawk, WI 54487; 715-453-3256.*

Late-model CRT tester and rejuvenator capable of testing the late-model tubes; also with charts still available. *B.L. Blackmore, Blackmore TV, 50155 Smiths Ferry Road, E. Liverpool, OH 43920.*

FOR SALE

Beckman 310 DVM, \$100; Sencore equipment: SC-60 scope, \$795; PR-57 Powerite, \$250; TF-46 transistor tester, \$125; LC-53 Z-meter, \$495; DVM-56 digital voltmeter, \$395; FC-51 frequency counter, \$625; SS100 desoldering station, \$125; VA-48 video generator, \$595. *Daniel Murphy, 1460 Groce Meadow Road, Taylors, SC 29687; 803-895-3410.*

Large quantity of radio and TV tubes, new and used, will sell in assorted boxes of six tubes each for \$10 plus \$2 shipping and handling or \$1 each plus \$3 shipping for boxes of 25 or more; large quantity of Sams from 2,000 down to 100, most are below 1,800—for list and special pricing for quantity, send SASE; also have a lot of test equipment. *Dave Merrell, 1123 Knollwood, Jackson, MI 49203; 517-787-4873 or 789-6717.*

Three Heathkit electronics courses (electronic communications, semiconductor and solid state, and test equipment), all brand new, include all parts for the experiments and a factory-wired trainer, never used, \$250 for all; 30 electronic books in excellent condition, \$100 for all. Add UPS. *Daniel Seidler, 3721 W. 80 St., Chicago, IL 60652; 312-284-8221.*

Wurlitzer 12FQ8 organ tubes, about 20 pulled from damaged, working organ, \$3 each or all for \$45. *Walter Schwartz, 621 Eastview St., Elgin, IL 60120; 312-679-5668.*

Sencore SC61, used less than 50 hours, has all manuals, probes and adapters, in like-new condition, \$2,000. *Gary Hoppe, Box 7091, Spenser, IA 51301; 712-262-5949.*

Start your own business with our selection of nearly new test equipment, service manuals, parts, etc. Everything needed for TV, VCR, CB and miscellaneous repairs. Good offer could take all. Call collect for more info and ask for Jeff or Deb, 717-677-6014. *Cramer Electronics, P.O. Box 322, Bendersville, PA 17306.*

TV parts from A to Z, let me know what you need. Send post card. *Gary Barzily, 84-39 120th St., Kew Gardens, NY 11415; 718-847-7965.*

RCA video disc player, \$50; Stanley model 1205 garage-door opener, \$50; A.W. Sperry model 620-C 20MHz dual-trace scope, \$250; Heath IM-2400 frequency counter, \$75; Heath GS-4500 video organizer, \$25; Heath IPA-5280-1 ac power supply, \$15; Heath IG-5282 audio generator, \$20; Heath EE-3201 digital techniques course, \$75; Heath EE-3105A electronic test equipment course, \$75; Mark IV-C Subber TV tuner, \$20; Philmore model FS45 SWR bridge & field-strength meter, \$10; Radio Shack model 22-124A 12V reg. power supply, \$15; Adam computer system, \$100; FCC commercial radio operator license course, \$50. *T.W. Kennedy, P.O. Box 156, Dayton, OH 45428; 513-263-2586.*

Brand-new Quasar H.V. transformer #24D70809A04 for TS-931 chassis, replacement for 24D70148A09 and sub for 24D70148A07. \$25. *Jasper Vitello, 717 B West Mahoning St., Punxsutawney, PA 15767.*

Simpson Electric model 467 DMM. measures up to 1,000Vdc, 750Vac (true RMS), 2A ac/dc, 20M Ω , includes leads and battery, \$100; HP model 130C scope, 500kHz bandpass, identical vertical and horizontal amplifiers from 0.2mV/CM to 20V/CM, internal and external triggering, 21 linear sweep times from 1 μ s/CM to 5s/CM, magnifier, internal calibrator, \$195; Tektronix model RM504 scope, 450kHz bandpass, single vertical input from 5MV/CM to 20V/CM, internal and external triggering, 18 linear sweep times from 1 μ s/CM to 0.5s/CM, horizontal amplifier, internal calibrator, \$165. COD or add \$10 for insured UPS shipping. *Fred Jones, 407 Morningbird Court, Niceville, FL 32578; 904-678-1803.*

Sencore VCR test equipment: VA62 analyzer, VC63 VCR test accessory, NT64 NTSC pattern generator and EX231 acc. expander, \$2,600 or best offer. *Dick Leach, Davis Communications, 117 S. Chestnut St., Jefferson, OH 44047; 216-576-1177.*

TV test equipment; Sams; new TV modules with caddies, some tubes—Zenith, GE, Motorola, Quasar and Magnavox. Send SASE for list. *Edward Roberts, Route 716, Millpoint Road, Achilles, VA 23001; 804-642-3613.*

Sony Beta alignment tapes, \$10 each or four for \$25; RCA WR-99-A crystal calibrated signal generator, \$20; RCA WG-300B oscilloscope probe, \$10. Add shipping. *J. Cruz, P.O. Box 3974, Langley Park, MD 20787.*

Sams Photofacts #800-#2292, includes metal files, \$2,500 or best offer. Add shipping. *Calvin Boddie, 660 E. Yucca St., Oxnard, CA 93030; 805-486-1071 after 4 p.m.*

Belden 8718 12-gauge, 2-conductor shielded cable in Unreel 475, \$225; SME type 3 tonearm, new with original packing/paperwork, never mounted, \$150; Winegard AT-2000 antenna, new in box, \$28. All prices include shipping. *Doug Dornbos, 4293 Eaglecrest, Williamsburg, MI 49690; 616-938-2767.*

Sams Photofacts, TV series #1300 through #1829, \$850; CB series over 100, \$300 for all or \$8 each;

older AR series. Frank Wolff, 6 White St., Topsham, ME 04086; 207-729-0566 after 5 p.m.

Transistors (approx. 235) for IF, VID, AGC, SYNC, audio, horizontal and vertical. No reasonable offer refused. Jerry Finkel, 4924 NW 54th Court, Fort Lauderdale, FL 33319.

Lampkin 107C service monitor with all accessories and manual. Jerry's Radio Service, 409 S. Oklahoma St., Shamrock, TX 79079; 806-256-3405.

Motorola model SI056A portable test set for 2-way repair, freq. 25-960MHz, \$200; B&K model 466 CRT tester, \$50; B&K model 1246 digital generator, \$45. J. Driscoll, 220 Marshall St., Des Plaines, IL 60016; 312-593-1074.

Vacuum tube grab box: about 180 tubes, boxed and numbered, about 40% new, \$20 plus shipping and handling. John Elias, 3525 Sage Road, #310, Houston, TX 77056; 713-622-4764.

Sencore CR161 rejuvenator/tester, \$70; Heathkit model IT-17 tube tester, \$25; Heathkit model IM-17 solid-state voltmeter, \$15. All with manuals, shipping extra. Jonathan R. Kiser, 295 Hooker Ave., Poughkeepsie, NY 12603; 914-473-1118.

Realistic DX100 solid-state general coverage receiver, 520kHz to 30MHz, \$50; Teac V360C stereo cassette deck, \$50; Bose 550 stereo receiver,

40W rms per channel, \$185. All prices include prepaid UPS to any street address in the continental United States. Donald Nash, 1444 Pulaski St., Port Charlotte, FL 33952.

NAP chroma, deflection, IF modules for sale at 60% retail plus shipping—all new, mostly for E40 and E50 chassis; tubes 60% off list: 19VBR (two available), 23EGP22A, 25AP22, 25AUP22, C22UP22, 25UP-22, \$20 for B&W, \$35 for color plus shipping. R.N. Yasko, Fremont TV & Electronics, 407 E. Main St., Fremont, WI 54940; 414-446-2239.

Rider manual, etc., early Sams Photofacts, two lots about 2,000 in file cabinets, all for \$200. Tony Kray, Main St., Putney, VT 05346.

Wollensak T-1515 7 1/2-inch reel-to-reel stereo tape recorder with cables, microphone and reels, in original box; Sencore TF-1662 auto. transistor analyzer, 7 1/2-inch meter, in original box with leads and manual; Lafayette base CB Telesat 23 with mike, cords and manual; Eico model 221 VTVM, 4 1/2-inch meter, leads and manual; Mercury model 1101 tube tester with manual. Good deals. Pat LoSquadro, 157-29 82 St., Howard Beach, NY 11414; 718-641-4501.

Sacrifice from a business that never really got started—Sencore equipment, used less than 100 hours: VA 48, \$450; SG-165, \$350; B&K 1248 color-bar generator, \$75. All excellent, with

manuals, cables, extras, in original boxes. Tom Sherman, 182 River Loop Road, Tonasket, WA 98855; 509-486-2839.

B&K model FE 21 FET, \$195; Sams Photofacts, #1000 to #1500, \$3 each; semiconductors, 50% off wholesale—send SASE. George Pullen, 8601 Temple Hills Road, Lot 122, Temple Hills, MD 20748; 301-397-9374.

JVC model PUJ48075-2 VCR torque gauge, like new, in original shipping package, \$150. Clarence G. McKee, 9516 Zion Road, Rives Junction, MI 49277; 517-569-3139.

Metal detector, Compass X-100 Challenger, like new, with accessories. Joseph Zambri, RD 4 Box 216, Towanda, PA 18848; 717-265-4825.

Sams Photofacts, #160 to #1000, \$4 each; many older-type receiving tubes. Wes Woods, Rt. 1 321-34 Road, Palisade, CO 81526.

Sencore SC61, VA62 and more complete setup, all in excellent condition. Pat Montague, TeeVax, 422 Wilson St., Santa Rosa, CA 95401.

Will trade Fluke 8050A DMM for Sencore VA48; sell/trade B&K 1601 power supply, \$125, B&K 1077, \$85, Sencore DVM32, \$45, Beltron 2972E, \$200 WANTED B&K520B or 530. Make offer. Slim Goodwin, 1712 Alvarado NE, Albuquerque, NM 87110; 505-265-9359.

ES&T

Classified

Advertising rates in the Classified Section are \$1.65 per word, per insertion, and must be accompanied by payment to insure publication.

Each initial or abbreviation counts as a full word.

Minimum classified charge \$35.00.

For ads on which replies are sent to us for forwarding (blind ads), there is an additional charge of \$40.00 per insertion to cover department number, processing of replies, and mailing costs.

Classified columns are not open to advertising of any products regularly produced by manufacturers unless used and no longer owned by the manufacturer or distributor.

FOR SALE

TV TOUGH DOGS: 300 symptoms and cures. Send \$7.95 to DAVIS TV, 11772 Old Fashion Way, Garden Grove, CA 92640. 10-87-tfn

CB RADIO REPAIRS/MODIFICATIONS: Books, plans, kits, high-performance accessories since 1976. Catalog \$2. CBCI, Box 31500E, Phoenix, AZ 85046. 10-88-41

TV/VCR REPAIR TIPS VOLUMES I AND II. Each with 1,000 up-to-date problems/cures listed by model and chassis for quick easy lookup. \$29.95 per volume. Add \$2.50 postage and handling. Computer Assistance, Box 232026, Anchorage, AK 99523. 11-88-31

MATTER CONVERTER? Would you like to build one? For more information send \$10.00 & SASE to Donald M. Scott, Dept. 1, P.O. Dwr. 1180, Verona, MS 38879. 12-88-21

COMPUTER TV/VCR REPAIR TIPS DATABASE PROGRAM (IBM Compatible w/hard drive). Scan symptoms and cures by model or chassis. Add, change, delete, print out. \$49.95 for program. \$69.95 includes database with over 1,000 up-to-date repair tips. Add \$2.50 postage and handling. Computer Assistance, Box 232026, Anchorage, AK 99523. 11-88-31

INTEGRATED CIRCUITS—Lowest prices on Admiral, G.E., NAP, Philco, RCA, Sears, Sylvania and Zenith types. Write PEC, Box 894, Union, N.J. 07083. 11-88-41

PHOTOFACTS: Folders under #1400, \$4.00. Above #1400, \$6.00. Sent same day first-class postpaid. Loeb, 414 Chestnut Lane, East Meadow, NY 11554. 12-88-31

TV/VCR TUFF TIPS listed by mfg. & model. Over 400 tips. \$21.95. TV Tips only \$11.95, VCR Tips only \$13.95. **VCR CROSS-REFERENCE** listing for electronically similar manufacturers, RCA, GE, Sylvania, Panasonic, Quasar, Magnavox, Philco, & J.C. Penney, \$19.95. **TV/VCR FAILURE HISTORIES.** Multiple cures for most problem areas. Send \$7.95 with mfg. and model number. Money will be refunded with free sample if model is not on database. Add \$1.50 postage and handling. TECH CURES, 4825 Fredericksburg Road, San Antonio, Texas 78229. 12-88-TFN

TV TROUBLESHOOTING: 300 PROBLEMS/SOLUTIONS. 3 VOLUME SET. NOTHING OLD LISTED. \$12.00 PER SET OR \$5.00 PER VOLUME. JONES, BOX 702, NICEVILLE, FLORIDA 32578. 01-89-TFN

VHS-VCR Repair Solutions Volumes I, II, III, IV. Each contains 150 symptoms and cures, cross reference chart, free assistance. Each \$11.95, any two \$19.95, any three \$29.95, all \$39.95. Eagle Electronics, 52053 Locks Lane, Granger, IN 46530. 01-89-TFN

REDUCED 75%, Diehl Mark V scanner \$249, Diehl Mark III scanner \$99. New. 2805 University Ave., Madison, Wis. 53705, 608-233-9741, 608-238-4629. 01-89-21

BUSINESS OPPORTUNITIES

AVALON, NEW JERSEY: TV sales and service store and shop with duplex. Excellent investment at South Jersey Shore. 2 blocks from beach. Authorized franchise for SONY, QUASAR, SYLVANIA, PHILCO, ZENITH. Established business founded in 1957. Gross sales in excess of \$300,000 yearly. Contact Leahy Realty, Inc. 609-967-5070. 01-89-11

TV, VCR, APPL. SALES, SERVICE AND RENTAL BUSINESS WITH 3 STORES \$25,000 buys service department and you manage \$100K in rental contracts for commission. Or will sell all stores for \$250K. Financing available for qualified buyer. Located in Northern Virginia. Call after 7:00 p.m. est. 703-972-7027. 01-89-TFN

TC/VCR SALES AND SERVICE: Maryland, 20 miles south of Washington, DC. With or without real estate. Established 25 years. 301-743-3153. 01-89-11

4 SALE TV Sales & Service with Post Office Contract station in So. Ca. coastal town. Call (805) 646-5818. 01-89-11

BOCA RATON FLORIDA TV-VCR Sales-Service. Small shop 16 years profitable. Call 407-392-8759 or write 127 E. Palmetto Pk. Rd. Boca Raton, FL 33432. 01-89-11

OPEN YOUR OWN Electronics parts store, over \$70,000, acquisition cost, inventory, asking \$15,000. Call Bill, 305/232-6349 for information. 12-88-21

FIX VCR's

3 out of 4 VCR breakdowns are due to mechanical problems.

Do you have the tools to find these problems?



TENTEL® Does!

Call Toll Free

(800)538-6894

In Calif -(408) 379-1881

TENTEL

Circle (21) on Reply Card

HAND REMOTE REPAIR
LA GUARDIA ENT
 5882 Rich Hill Way
 Yorba Linda, CA 92686
 (714) 579-1276

90 Day Warranty
 New Battery Included

- Call for pricing
- 24 hr. turnaround time
- Return freight pre-paid

Circle (23) on Reply Card

NEW LOW PRICE \$39.95

TEST/CLEAN/RESTORE with a UNIVERSAL CRT ADAPTER that fits all CRT testers and quickly hooks-up to all CRT's on the market (now or in the future). Guarantees profit & total CRT servicing. Used by TV Repair, US Govt., Airlines, Computer Serv., Dept. of Defense. Patented Adaptor-Sockets-CRT Reference/Setup book—Only \$39.95 plus \$2.50 postage & handling. Our 6th year. Over 15,000 sold. Chargecards/Checks/COD. Money Back Guarantee.

FREE CALL 1-800-331-9658

DANDY MFG. CO./RANDALL ELECTRONICS
 (918) 682-4266, 2323 Gibson St., Muskogee, OK 74403

Circle (22) on Reply Card

"Tech's Guide To Pricing"
 updated new 5th edition...a framework for setting rates that apply to Hi-Tech products...a formula that guarantees SUCCESS!

Call Toll Free for details
1-800-228-4338 8/5 CST

Circle (24) on Reply Card

MOVING?

Take us with you.

Just peel off your subscription mailing label and attach it to the address change card inside this issue. Please allow 6-8 weeks to process your address change.

Ad Index/Hotline

Company	Page Number	Reader Service Number	Advertiser Hotline
Chemtronics, Inc.	21	10	800/645-5244
Chicago Case Co.	41	16	
Consolidated Electronics, Inc.	65	18	800/543-3568
Dandy Mfg. Co.	68	22	800/331-9658
ETA	65		
Fluke, John Mfg. Co., Inc.	5	6	800/227-3800
Hitachi Sales Corp. of America	27	12	516/921-7200
Iscet	63		
Laguardia Enterprises	68	23	714/579-1276
Leader Instrument Corp.	3	4,5	800/645-5104
MCM Electronics	45	13	800/543-4330
Mitsubishi	1	3	800/553-7278
National Advancement Corporation	47	14	714/754-7110
Nesda	45,47		
Parts Express Int'l., Inc.	49	15	513/222-0173
Philips ECG	13	8	800/225-8326
Prime Electronics	63	20	414/473-4727
Sencore, Inc.	IFC	1	800/843-3338
Simpson Electric Co.	23	11	312/697-2260
Sperry Tech, Inc.	68	24	800/228-4338
Tektronix, Inc.	8-9	7	800/835-9433
Tektronix, Inc.	8A-8B		800/835-9433
Tentel	68	21	800/538-6894
Tronix, Inc.	55	17	313/939-4710
U-Can-Do VCR Educational Products Co.	59	19	513/548-6113
Windsor Technologies, Inc.	19	9	415/456-2200
Zenith		BAC	

ADVERTISING SALES OFFICES

ELECTRONIC

Servicing & Technology

KANSAS CITY, MISSOURI
 Greg Garrison, Sales Manager
 P.O. Box 12901
 Overland Park, KS 66212
 Phone: (913) 888-4664
 Fax: (913) 888-7243
 Telex: 42-4156 INTERTEC OLPK

OXFORD, ENGLAND
 Nicholas McGeachin
 Roseleigh House, New Street
 Deddington, Oxford OX5 4SP
 Phone: (0869) 38794
 Telefax: (0869) 38040
 Telex: 837469 BES G

TOKYO, JAPAN
 Haruki Hirayama,
 EMS, Inc.
 Sagami Bldg., 4-2-21, Shinjuku,
 Shinjuku-ku, Tokyo 160, Japan
 (03) 350-5666
 Telex: 2322520 EMSINCJ
 Cable: EMSINC PERIOD

FREWVILLE, SOUTH AUSTRALIA
 John Williamson
 Hastwell, Williamson, Rep. Pty. Ltd.
 109 Conyngham Street
 Frewville 5063
 South Australia
 Phone: 799-522
 FAX: 08 79 9735
 Telex: AA87113 HANDM

Service market penetration. Times two.



MSM magazine delivers the computer service industry's buyers—32,000 service managers.

ES&T magazine delivers the consumer electronic service industry's buyers—43,000 service professionals.

Together, they round out your market penetration to the entire service industry spectrum.

And here's the best part of this ideal media mix: Generous combination frequency ad rate discounts mean twice the market reach for you...at substantially reduced rates in both magazines!

Why settle for only half of your marketing potential? Put your advertising on double-duty in MSM and ES&T... **and increase your sales to the entire service industry.**

Call (913) 888-4664 for more information.

**For your own reputation
and in your customers' best interest
always insist on**

Genuine Zenith
Remanufactured Replacement Parts
Reconditioned and Serviced for Reliability
by Zenith People
as Knowledgeable and Dedicated as
Those Who Made the Originals!

One of the easiest, fastest, and surest ways for you to preserve the pedigree and maintain the quality of the Zenith products you service is with genuine Zenith replacement parts.

And at no time is this more critical than when you replace the more sophisticated components like modules, tuners, channel selectors and sub-assemblies.

Your participating Zenith parts distributor will supply you with a replacement remanufactured, reconditioned and serviced for reliability by Zenith people as dedicated and knowledgeable as those who made the original.

Equally important, the replacement module or sub-assembly you receive in exchange from your Zenith parts distributor

will most likely incorporate any Zenith factory-made modifications in effect at the time of remanufacture.

And nowhere else but in a participating Zenith parts distributor's Exchange Program can you get assurance that a replacement incorporates Zenith factory up-dates!

To learn the location of the Zenith R&R Exchange Counter in your area, write on your company letterhead and we will help you locate one that's nearby.

Risking an exchange for a Zenith replacement anywhere else doesn't make sense. Not when factory-fresh replacement modules and sub-assemblies are so readily available thru a Zenith parts distributor's Exchange Program! Write now!



The quality goes in before the name goes on.®